

## Distance sensors from SensoPart

Accurate and non-contact distance measurement for automation technology



## Distance sensors

Accurate and non-contact distance measurement for automation technology

With our portfolio of distance sensors, we cover a broad spectrum of industrial automation technology. Sensors for short range work according to the measuring principle of optical triangulation, sensors with working ranges above one meter, on the other hand, work according to the principle of time-of-flight measurement (time-of-flight technology).

### Highlights:

- Fast and accurate measurement, precise positioning and detection of a wide range of materials
- IO-Link sensors can be operated in IO-Link mode or standard I/O mode
- Many interfaces - classic analogue or serial, or IO-Link

Furthermore, our portfolio of distance sensors also includes ultrasonic and inductive sensors.



Our distance sensors can be used across all sectors

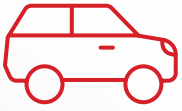

Automotive industry



Assembly & Handling



Robotics

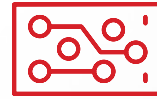

Electronics

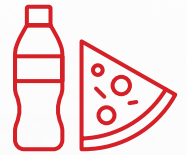

Food & Beverages



Plastics technology

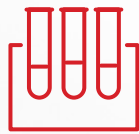

Lab automation



Pharmaceuticals  
& Cosmetics

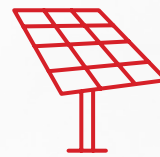

Solar industry



Packaging technology

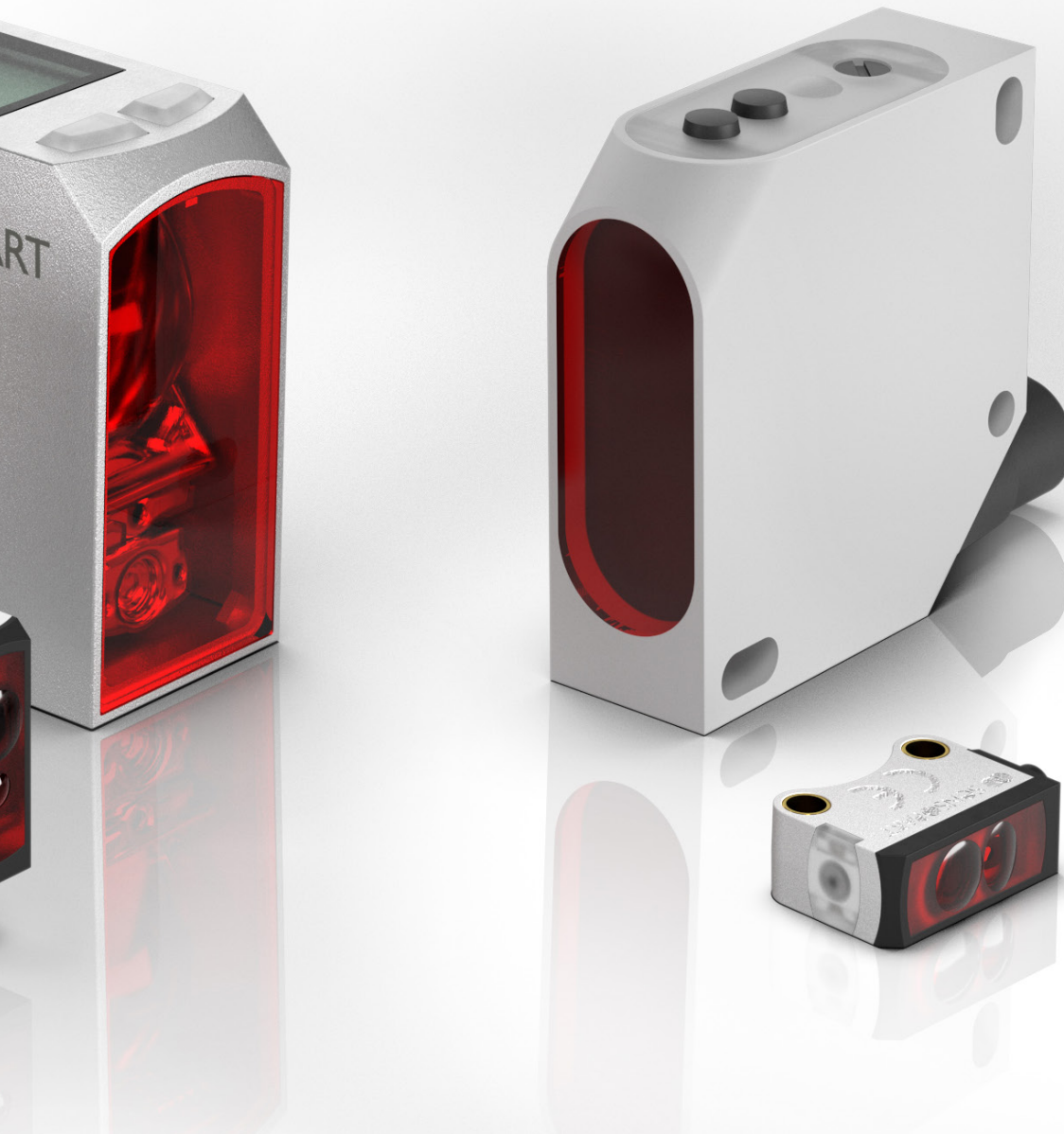

# Triangulation sensors

for near-field applications (up to 1000 mm)

FT 10-RLA



FT 25-R(L)A



FT 50-RLA



FT 55-RL(2)AM



# Time-of-Flight sensors

for long working distances (up to 70 m)

FT 55-RLAP



FR 55-RLAP





QR code for further information

# Interconnected system architecture

EtherNet/IP™

Efficient, communicative, scalable

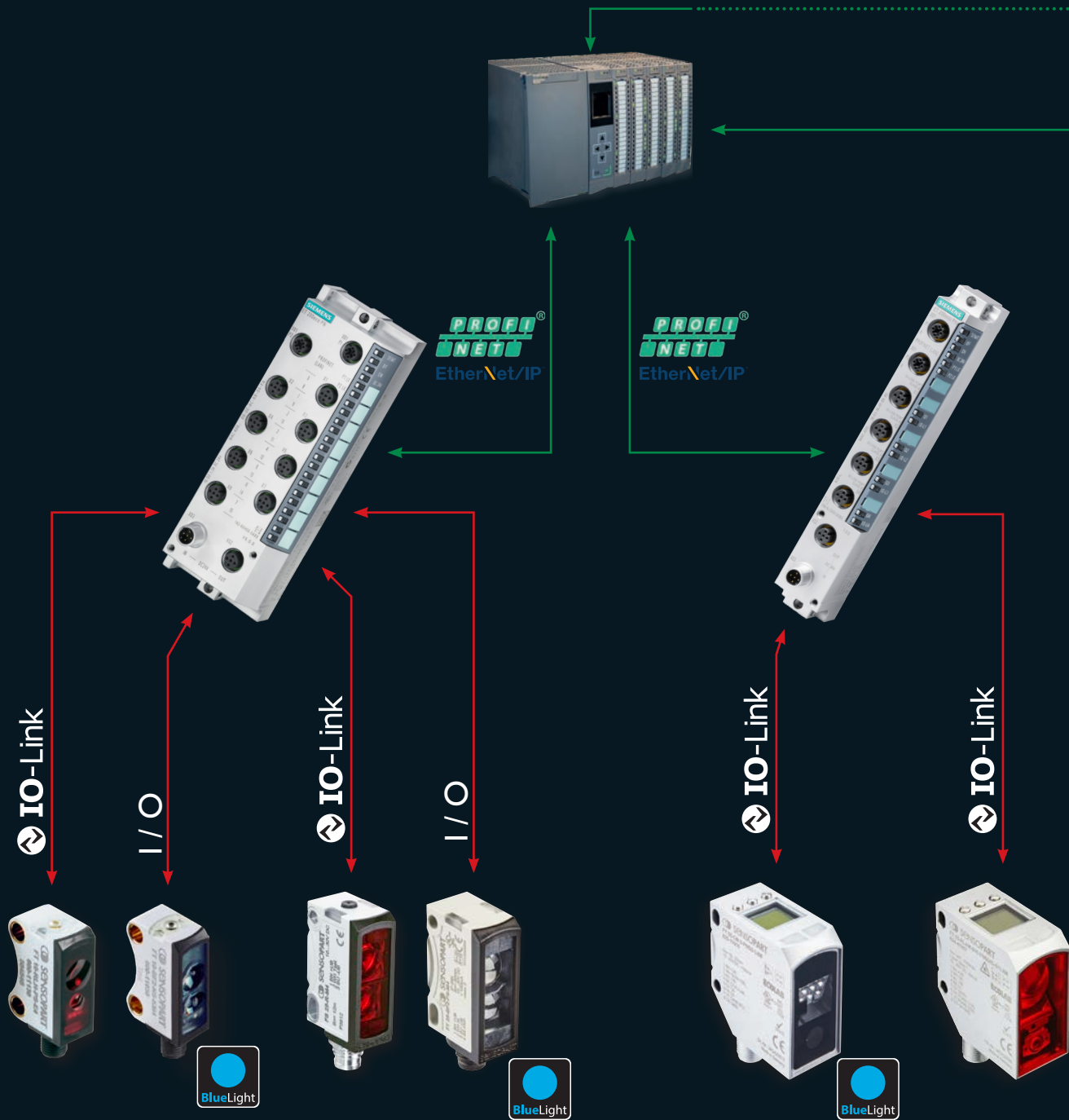

## Automated communication

When data storage is enabled, the master saves the settings and transfers them to the new sensor. All IO-Link sensors from SensoPart support this function.

## Simple

Use of existing unshielded IO cables, up to 20 m in length for IO-Link sensors.

## Cost-saving

Fast installation through simple, decentralised cabling. Less cables = less effort.

## Transparency

Two-way communication up to the lowest field level, allowing greater transparency. Availability of a large amount of relevant data, e.g. for condition monitoring.

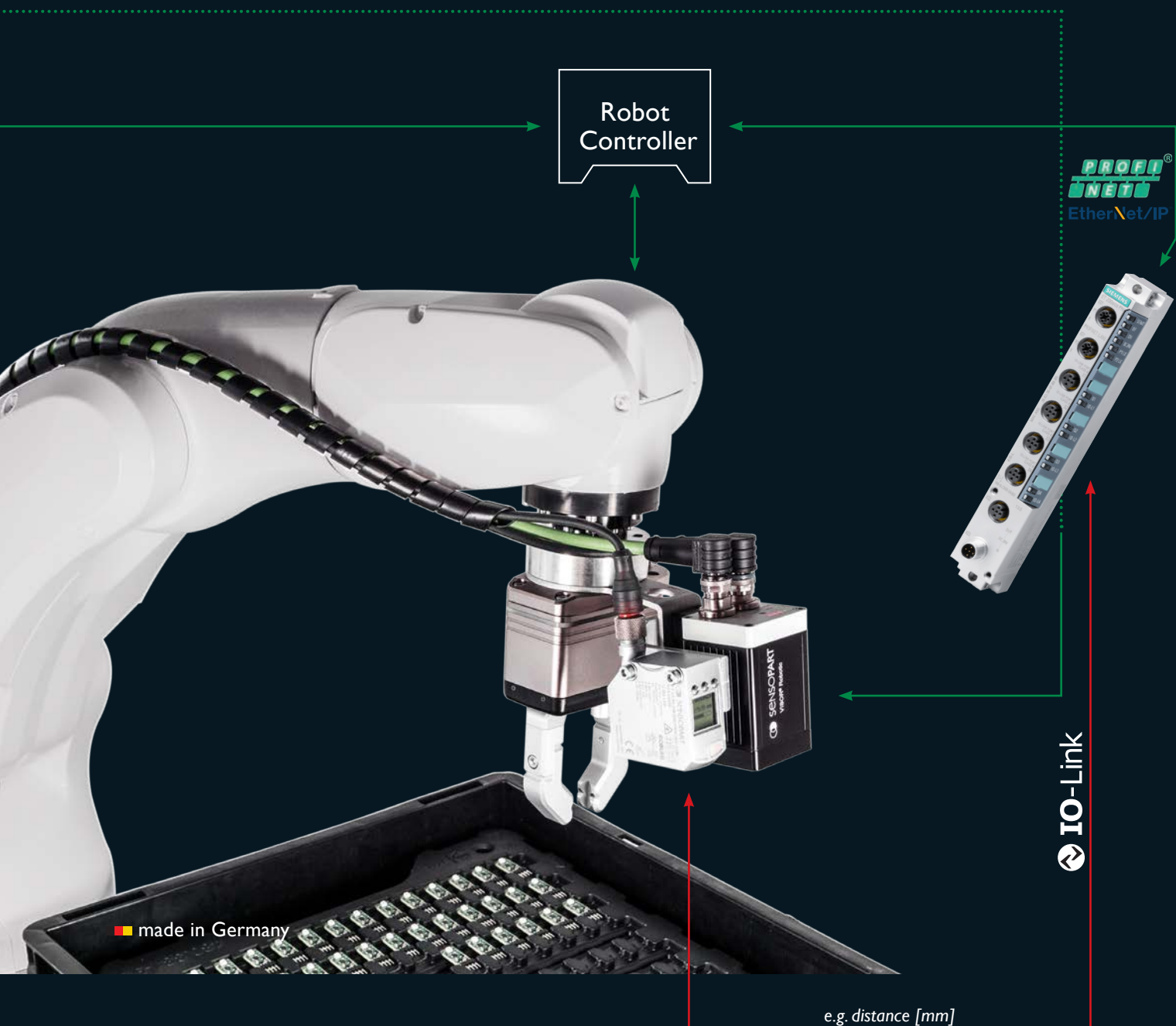

made in Germany

e.g. distance [mm]

### Versatility

Combined use of IO-Link and binary sensors is easily possible on the IO-Link Master. All IO-Link sensors from SensoPart can also be operated in standard binary mode.

### Functionality

Example FT55-CM: output of color values via IO-Link, additional functions (e.g. smart functions) are directly in the sensor.

### Precision

The digital transfer of previously analogue measurement values avoids cable-related transmission errors and the general limitations of analogue measuring technology. This enables considerably higher transmission accuracy.

### Compatibility

The cascability of the IO-Link Master allows combinations with other Profinet / EthernetIP devices. For example, in robotics applications, the X and Y value and also rotation can be detected with the VISOR® and the Z value with a distance sensor. This architecture also reduces cabling work.

# Distance sensors

Accurate and non-contact distance measurement for automation technology

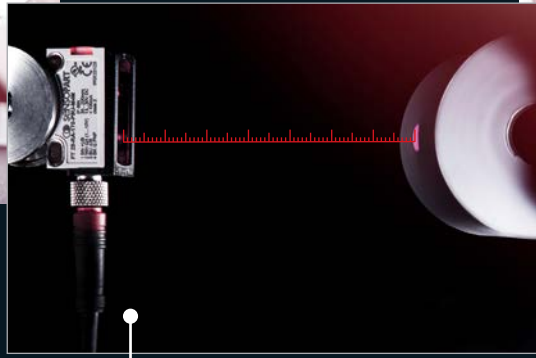

0 mm

70 mm

300 mm

500 mm

## Fits in every gap

Weighing and measuring no more than a sugar cube, the **FT 10-RLA** sensor fits in virtually every space. For example, the sensor controls the distance to textiles in industrial sewing machines, guaranteeing more precise stitching.

## The compact class for measurement and control tasks

The **FT 25-R(L)A** distance sensor accurately determines the roll diameter of an unwinding machine and therefore supplies early information about an impending roll change. Designed in small housing for easy integration, it offers excellent precision regardless of the surface properties of the object detected.

## Precisely positioned

Typical applications of the **FT 50-RLA** include determining the correct position of components in the assembly process, e.g. in assembly lines. Due to its outstanding sensor technology, the sensor is also able to reliably detect and inspect details.

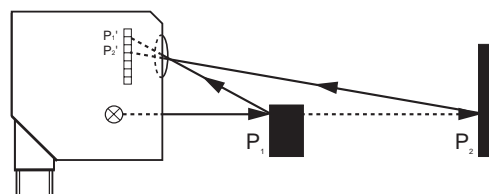

Triangulations-Principle





1 m

### A secure grip

The smart laser distance sensor **FT 55-RLAM** ensures that e.g. stacked components are gripped with utmost precision. Thanks to high repeatability and linearity, the sensor always reliably grips the part in the correct place, with virtually any type of surface.

5 m

### Universally suitable for large distances

The **FT 55-RLAP** allows long scanning ranges up to 5 m, ideal for checking the occupancy of storage bays in high bay warehouses.

70 m

### Long scanning range

Thanks to its long scanning range of up to 70 m, the reflector device **FR 55-RLAP** is ideal for detecting the exact position of overhead cranes or determining the distance between forklift trucks.

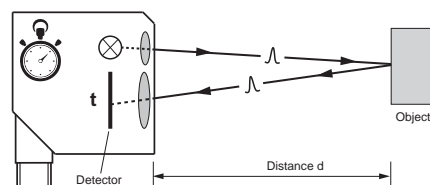

Time-of-flight technology

# FT 10-RLA – Our smallest optical distance sensor

Subminiature distance sensor for precise measurement tasks in confined spaces

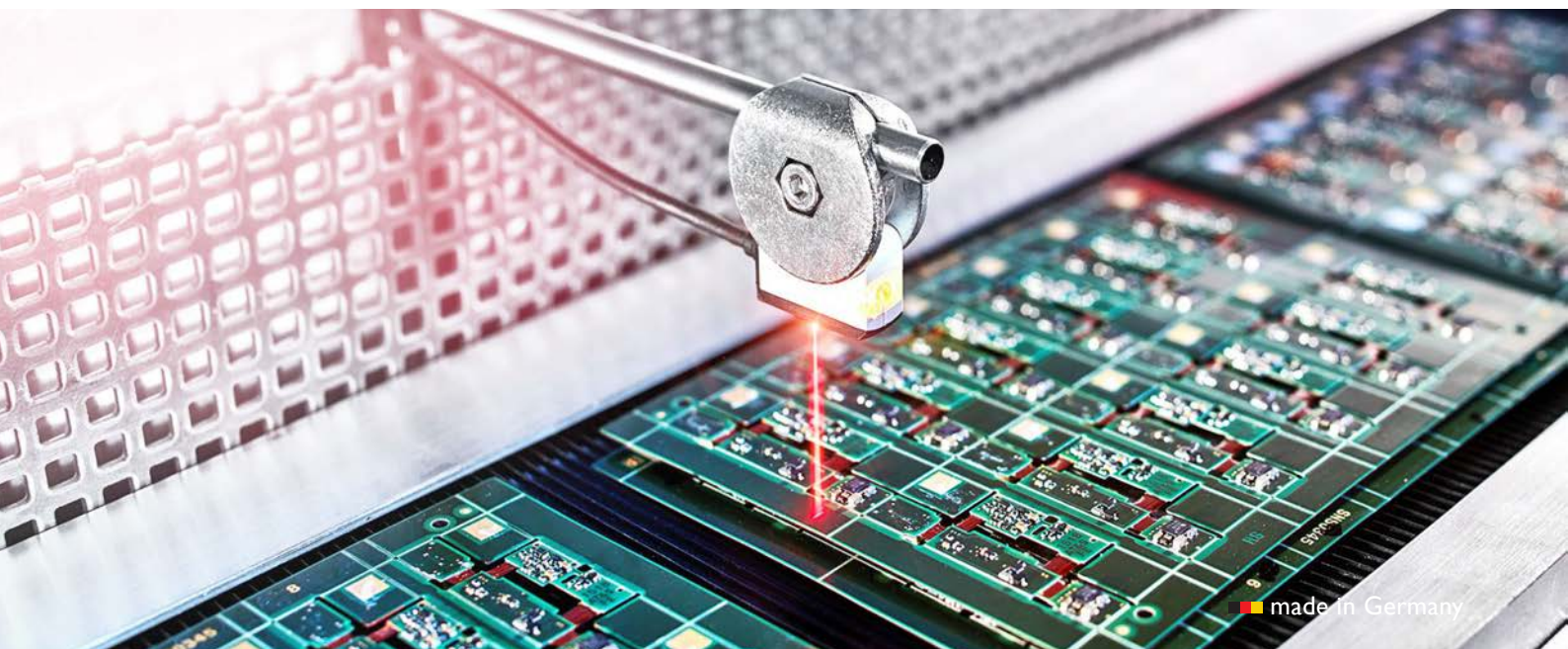

## When things get too cramped:

The FT 10-RLA demonstrates outstanding ability, even in extremely cramped installation conditions. As the smallest optical distance sensor in the world, it is ideally suited to challenging measurement tasks, e.g. during assembly of semi-conductor devices or in robotics applications.



**Small but powerful**  
Measuring just 21.1 x 14.6 x 8 mm in size and only 10 grammes in weight, it is scarcely larger than the tip of your finger – and therefore ideal for cramped conditions.

## TYPICAL FT 10-RLA

- Minimum weight, ideal for robotics applications
- Also suited to smallest installation space thanks to minimal dimensions, e.g. as a replacement for fiberoptics
- Output of measured values via IO-Link
- Excellent sensor characteristics with repeat accuracy and linearity
- Measuring range 10 to 70 mm
- Laser class 1 for optimum eye safety

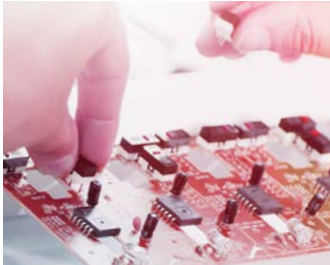

Checking accuracy of installation or presence of components



Presence and position measurement of mobile robots in warehouse processes



Distance measurement in robotics applications directly from the gripper

## Examples of industries and applications

### Robotics

- Determination of height jumps on the robot, e.g. to check the correct position of screws
- Output of presence and, if necessary, position during automated retrieval of containers

### Electronics manufacturing

- Double layer control of printed circuit boards
- Height control of components

### Assembly and handling technology

- Inspection of assembly accuracy

## FT 10 – Product Overview

Sensor	Type of light	Adjustment	Operating range	Special features	Further informationen
FT 10-RLA	Laser	Teach-in (key and control cable)  IO-Link	10 ... 70 mm	Laser; smallest housing, IO-Link	

# FT 25-R(L)A – Optical short-range distance sensors

The compact class for measurement and regulatory tasks



made in Germany

In addition to its analogue voltage output the small distance sensors **FT 25-R(L)A** also have a switching output and offer the possibility of defining a switching window by means of two switching points. Thanks to their easy operation, these sensors are particularly suitable for simple measurement and regulatory tasks at distances of up to 200 mm. Our laser and LED variants cover a very broad range of applications.

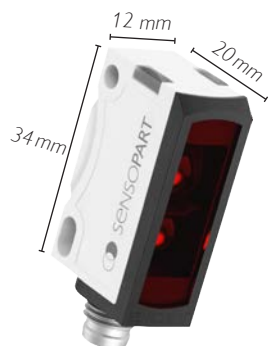

*In a miniature housing*  
The FT 25-R(L)A is also suitable for limited installation spaces thanks to its compact dimensions of 34 x 12 x 20 mm

## TYPICAL FT 25-R(L)A

- Operating range 20 ... 80 mm / 20 ... 100 mm / 30 ... 200 mm
- Analogue output (1 ... 10 V)
- Easily integratable ultra-compact ABS housing: 34 x 12 x 20 mm
- High precision and high repeatability – especially for control tasks
- Resolution: from 0.12 mm
- Two adjustable switching points as window mode for 2-point control
- Teach-in operation



**FT 25-R(L)A for dancer roll regulation:**  
The precise control of the FT 25-R(L)A ensures a constant tension of the paper roll during unwinding

## Examples of industries and applications

### Printing industry

- Determination of paper roll diameter (LED/Laser)

### Wood, packaging and handling industry

- Stack height control
- Double layer detection
- Height measurement (LED/Laser)

### „Pick & Place“ applications

- Distance measurement and positioning at the robot gripper arm (LED/Laser)
- Inspection of gripper opening or inspection of presence of objects in the gripper

### Small parts measurement

- O-rings and electronic components (Laser)

### Packaging industry

- Measurement on multi-colored and high-contrast objects (Laser)

### Plastic granules

- Level control of granular material (LED)

## FT 25-R(L)A – Product Overview

Sensor	Type of light	Adjustment	Operating range	Special features	Further informationen
FT 25-RLA	Laser	Teach-in (key and control cable) IO-Link	20 ... 100 mm	Laser, small housing, IO-Link	
FT 25-RA	LED	Teach-in (key and control cable) IO-Link	20 ... 80 mm / 30 ... 200 mm	Small housing with long range, IO-Link	

# FT 50-RLA – Laser distance sensors

Precise and rapid measurement with many extras



 made in Germany

The **FT 50-RLA** is the proven standard series of distance sensors from SensoPart. These distance sensors are particularly easy to commission thanks to their fixed operating distances. Voltage rises linearly with increasing distance. Regardless of the reflectivity of the target object, these sensors provide excellent measurement results and their comprehensive range of functions is impressive.



## TYPICAL FT 50-RLA

- Laser distance sensors with a variety of measurement ranges
- Shape and color of the target object is largely irrelevant
- High accuracy and resolutions
- Rapid response time up to 1 kHz
- Intelligent teach-in user concept
- 2 switching outputs
- Analogue output 4 ... 20 mA
- Variants with serial interface for measuring differences and thicknesses in difference measurement mode
- ABS housing with rotatable plug





### Examples of industries and applications

Automotive industry







Mechanical engineering

Wood processing

Packaging and printing industry

#### Independent of reflectivity

These highly precise triangulation sensors are predestined for the detection of differing materials thanks to their high contrast-independence.

FT 50 – Product Overview					
Sensor	Type of light	Adjustment	Operating range	Special features	Further informationen
FT 50 RLA-20	Laser 		40 ... 60 mm	Analogue output	
FT 50 RLA-40	Laser 		45 ... 85 mm	Analogue output	
FT 50 RLA-70 -100 -220	Laser 	Teach-in  (key and control cable)  PC 	30 ... 100 mm 70 ... 170 mm 80 ... 300 mm	Analogue output, switching outputs, simple teach-in of measurement ranges; RS485 interface	

# FT 55 RL(2)AM – The allrounder for distance measurement

Precise measurements easily adjustable

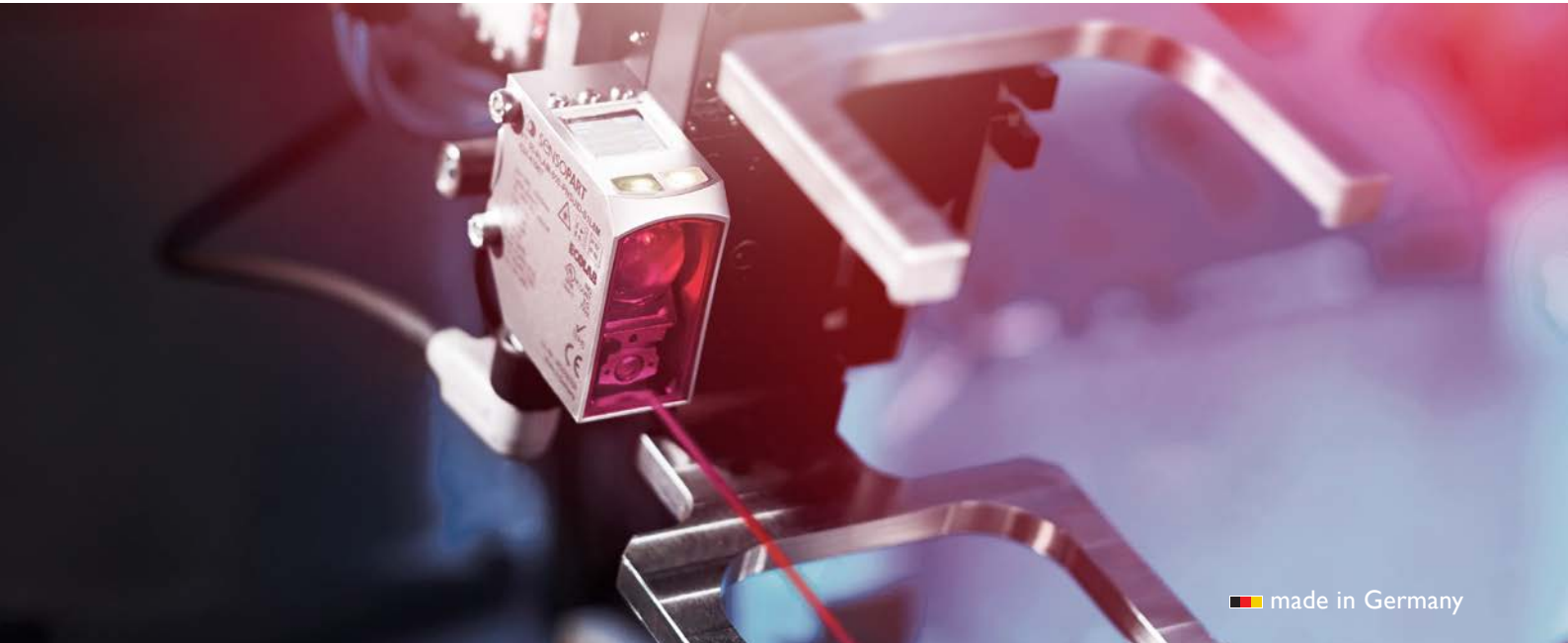

The compact distance sensor from SensoPart is a true allrounder. The FT 55-RLAM is reliably detecting surfaces from matt black tyres to highly glossy printed circuit boards. Offering extensive connectivity, the triangulation sensor is equipped with an analogue output, two switching outputs, an IO-Link interface and optional RS485 interface. The laser class 1 sensor comes with an innovative and user-friendly operating concept including a large LCD display, unusual in this performance category.



## TYPICAL FT 55-RL(2)AM

- Stable processes thanks to excellent sensor qualities across the entire operating range
  - Operating range from 80 to 1000 mm
  - Repeatability  $\leq 6 \mu\text{m}$
  - Linearity  $\leq 0.4 \text{ mm}$
  - Resolution  $1 \mu\text{m}$  via IO-Link
- Variant with laser class 2 for measurements on very dark objects
- Robust metal housing – sensor durability even in challenging processes
- Thickness or parallel differential measurement







## Examples of industries and applications

### Automotive industry

- Measurement on dark objects, e.g. unbalance of car tyres or brake discs
- Position measurement of components in assembly, e.g. at manual workstations

### Packaging industry

- Continuous monitoring of the diameter of a coil

### Robotics

- Determination of the exact position of car body parts

### Mechanical engineering

- Double layer control of metal sheets
- Measuring or checking the presence or correct positioning of metallic components, e.g. welding nuts on car bodies

## FT 55 – Product Overview

Sensor	Type of light	Adjustment	Operating range	Special features	Further informationen
FT 55-RLAM-320	Laser	Teach-in (key and control cable) IO-Link	80 ... 400 mm	Laser class 1	
FT 55-RL2AM-320	Laser	Teach-in (key and control cable) IO-Link	80 ... 400 mm	Laser class 2	
FT 55-RLAM-480	Laser	Teach-in (key and control cable) IO-Link	120 ... 600 mm	Laser class 1	
FT 55-RL2AM-480	Laser	Teach-in (key and control cable) IO-Link	120 ... 600 mm	Laser class 2	
FT 55-RLAM-800	Laser	Teach-in (key and control cable) IO-Link	200 ... 1000 mm	Laser class 1	
FT 55-RL2AM-800	Laser	Teach-in (key and control cable) IO-Link	200 ... 1000 mm	Laser class 2	

# F(T/R) 55 – Time-of-flight sensors with long scanning range

Compact sensors for precise measuring tasks and reliable object detection

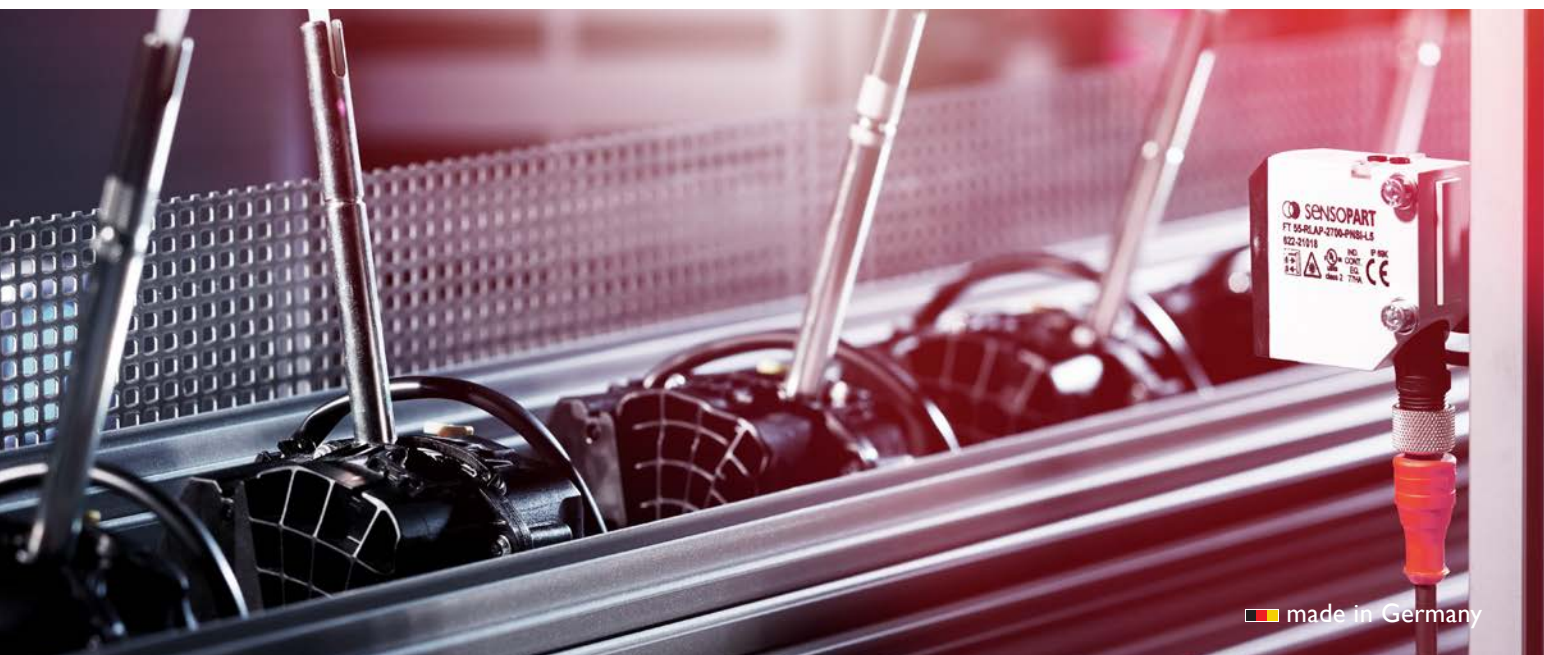

## Measuring distances: laser distance sensors with analogue output

The distance sensors of the type FT 55-RLAP that function according to the time-of-flight principle measure distances ranging from 60 mm to 5 m with utmost precision. They provide a signal that is proportional to the distance via the integrated analogue output (4 to 20 mA/0 to 10 V, invertible characteristics) and also have a switching output with switching window function that is adjustable independently of the analogue measurement range.



## TYPICAL F(T/R) 55

- Long ranges and scanning distances (up to 5 m on light objects and 3 m on dark ones)
- Reliable object detection against any backgrounds thanks to light time-of-flight process
- High switching frequency (500/250 Hz) for rapid processes
- High repeatability in the mm range
- Laser class 1 – for optimum security
- Glass-fibre reinforced, hermetically-sealed plastic housing (IP67/IP69K)
- Simple mounting and use (dovetail, teach-in)
- IO-Link with 2 switching outputs, smart functions and measured value output (distance sensors F55-RLAP)



**Reliable object detection:**  
Even objects with highly reflective metal surfaces and at critical measurement angles are reliably detected.

## Examples of industries and applications

### Robotics

- Detection of obstacles in autonomously driving vehicles, e.g. steps

### Automotive

- Presence detection of car body parts in the assembly process
- Emptiness control of load carriers in car body production











### Warehouse and conveyor technology

- Presence of pallets in high-bay warehouses

### Other

- Stack height or fill level control of roof tiles, pallets or cable reels

## F(T/R) 55 – Product Overview

Sensor	Type of light	Adjustment	Operating range	Special features	Further informationen
FT 55-RLAP	Laser 	Teach-in (key and control cable)  IO-Link 	0,1 ... 5 m	<ul style="list-style-type: none"> <li>• Analogue output 4 ... 20 mA and 0 ... 10 V (switchable via IO-Link), output of the measured value via IO-Link</li> <li>• Switching output with automatic detection PNP/NPN with switching point, window and hysteresis function (window teachable via key, switching point and hysteresis via IO-Link)</li> </ul>	
FT 55-RLAP2	Laser 	Teach-in (key and control cable)  IO-Link 	0,06 ... 5 m	<ul style="list-style-type: none"> <li>• Output of the measured value via IO-Link</li> <li>• Switching output with automatic detection PNP/NPN with switching point, window and hysteresis function (switching point teachable via key, window and hysteresis via IO-Link)</li> </ul>	
FR 55-RLAP	Laser 	Teach-in (key and control cable)  IO-Link 	0,3 ... 70 m	<ul style="list-style-type: none"> <li>• Sensor with long range up to 70 m for collision protection and positioning applications</li> <li>• Analogue output 4 ... 20 mA and 0 ... 10 V (switchable via IO-Link), output of measured value via IO-Link</li> <li>• Switching output with automatic detection PNP/NPN</li> </ul>	

# Technical data distance sensors

## Overview of technical characteristics

### Sensors for all operating ranges

	IO-Link	Start of measuring range [mm]	End of measuring range [mm]	Measuring range [mm]	10	50	100	200	300	400	500	600	700	800	900	1000
<b>F10</b>	FT10-RLA-60	✓	10	70	60											
<b>F25</b>	FT 25-RA-60	✓	20	80	60											
	FT 25-RA-170	✓	30	200	170											
	FT 25-RLA-80	✓	20	100	80											
<b>F50</b>	FT 50-RLA-20	–	40	60	20											
	FT 50-RLA-40	–	45	85	40											
	FT 50-RLA-70	–	30	100	70											
	FT 50-RLA-100	–	70	170	100											
	FT 50-RLA-220	–	80	300	220											
<b>F55</b>	FT 55-RL(2)AM-320	✓	80	400	320											
	FT 55-RL(2)AM-480	✓	120	600	480											
	FT 55-RL(2)AM-800	✓	200	1,000	800											
	FT 55-RLAP(2)	✓	100	5,000	4,900											
	FR 55-RLAP-70	✓	300	70,000	69,700											

### Linearity – precision across the entire measuring range

	End of measuring range [mm]	Linearity ± [mm]	Linearity [%] at end of measuring range		
<b>F10</b>	FT10-RLA-60	70	0.4	0.25 %	
<b>F25</b>	FT 25-RA-60	80	0.4	0.5 %	
	FT 25-RA-170	200	2	1.0 %	
	FT 25-RLA-80	100	0.25	0.25 %	
<b>F50</b>	FT 50-RLA-20	60	0.6	1.0 %	
	FT 50-RLA-40	85	0.85	1.0 %	
	FT 50-RLA-70	100	0.25	0.25 %	
	FT 50-RLA-100	170	0.425	0.25 %	
	FT 50-RLA-220	300	0.75	0.25 %	
<b>F55</b>	FT 55-RL(2)AM-320	400	0.2	0.05 %	
	FT 55-RL(2)AM-480	600	0.6	0.1 %	
	FT 55-RL(2)AM-800	1,000	1.5	0.1 %	
	FT 55-RLAP(2)	5,000	15	0.3 %	
	FR 55-RLAP-70	70,000	350	0.5 %	

## Repeatability - pinpoint precision

		Response time [ms]*	Repeatability [%] at end of measuring range	
<b>F10</b>	FT10-RLA-60	4	0.14 %	0.14
<b>F25</b>	FT 25-RA-60	0.4	0.50 %	0.50
	FT 25-RA-170	3.4	0.50 %	0.50
	FT 25-RLA-80	3.4	0.25 %	0.25
<b>F50</b>	FT 50-RLA-20	30	0.08 %	0.08
	FT 50-RLA-40	30	0.12 %	0.12
	FT 50-RLA-70	40	0.25 %	0.25
	FT 50-RLA-100	40	0.25 %	0.25
	FT 50-RLA-220	40	0.25 %	0.25
<b>F55</b>	FT 55-RL(2)AM-320	10	0.025 %	0.025
	FT 55-RL(2)AM-480	10	0.025 %	0.025
	FT 55-RL(2)AM-800	10	0.07 %	0.07
	FT 55-RLAP(2)	20	0.14 %	0.14
	FR 55-RLAP-70	10	0.05 %	0.05

\* Factory setting: Can be set via IO-Link and thus the repeatability can be optimized

## Accuracy in all circumstances

		Temperature drift [% / K] over measuring range
<b>F10</b>	FT10-RLA-60	0.02
<b>F25</b>	FT 25-RA-60	0.17
	FT 25-RA-170	0.12
	FT 25-RLA-80	0.13
<b>F50</b>	FT 50-RLA-20	0.05
	FT 50-RLA-40	0.05
	FT 50-RLA-70	0.02
	FT 50-RLA-100	0.02
	FT 50-RLA-220	0.02
<b>F55</b>	FT 55-RL(2)AM-320	0.01
	FT 55-RL(2)AM-480	0.01
	FT 55-RL(2)AM-800	0.01
	FT 55-RLAP(2)	0.02
	FR 55-RLAP-70	0.0005

# Other distance sensors

Ultrasonic sensors, Inductive sensors



## UT 20-S

### Miniature ultrasonic sensors with soundpipe

- Reliable detection through the smallest of openings and drilled holes
- Ideal for measuring filling levels of microplates and for scanning circuit boards
- PNP, NPN or analogue output options

## UT 20

### Miniature ultrasonic sensors

- High scanning distances of up to 700 mm with compact miniature housing
- PNP, NPN or analogue output options



## UT 12

### M12 ultrasonic sensors

- Robust metal housings for harsh operating conditions
- Simple installation with universal M12 standard thread
- Simple sensor setting via control input
- PNP or analogue output options



## UT/UM 18

### M18 ultrasonic sensors

- Robust brass or stainless steel housings for harsh operating conditions
- Simple installation with universal M18 standard thread
- Simple sensor setting via control input
- PNP or analogue output options

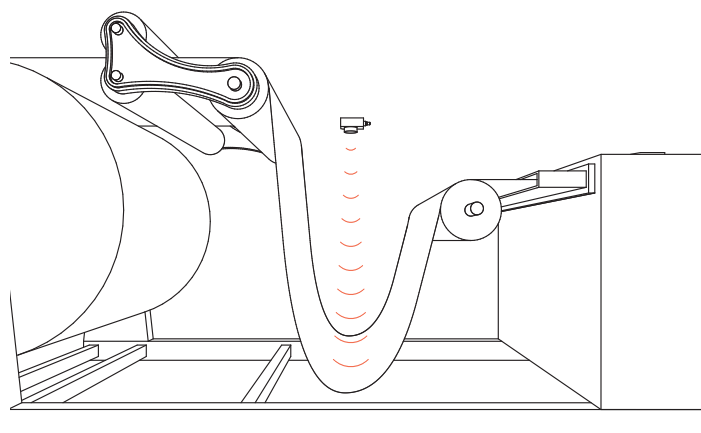

Continuity control with the UT 20 ultrasonic sensor



 made in Germany

### UMT 30

#### **M30 ultrasonic sensors with display**

- Long scanning distances up to 6 m
- Simple adjustment and direct measurement value output via display
- Automatic synchronisation and multiplex operation for the simultaneous operation of up to 10 sensors
- Numerous supplementary functions (add-on menu)
- 1x PNP, 2x PNP or analogue output options

### Inductive sensors

#### **Cubic housings**

- Housing sizes with metric thread M8, M12, M18, M30
- Switching distances up to 40 mm
- Excellent accuracy and temperature stability
- Resolution in  $\mu\text{m}$  range
- Analogue output 0 to 10 V or 4 to 20 mA

#### **Ultrasonic Sensors**

Ultrasonic sensors are used for materials where optical systems cannot be operated reliably. They work according to the time-of-flight principle of sound: The sensor emits ultrasonic pulses, which are reflected by the detection object. The sensor measures the pulse travel time and thereby calculates the distance value.

#### **Inductive analogue sensors**

Inductive analogue sensors are an inexpensive solution for the detection of metallic objects. They have limited ranges compared to optical or ultrasonic sensors. Due to their robustness, they are used especially in harsh environmental conditions.

**SensoPart** is one of the leading manufacturers of photoelectric sensors and image processing vision sensors for factory automation. We also offer inductive and ultrasonic sensors, thereby covering a wide spectrum of industrial automation tasks. Our products are used in countless applications and sectors today – from automotive construction and mechanical engineering to electronics manufacturing and the solar industry, as well as the food sector and pharmaceutical industry.



## SensoPart worldwide

### **Germany**

SensoPart  
Industriesensorik GmbH  
Nägelseestraße 16  
79288 Gottenheim  
Phone +49 7665 94769-0  
info@sensopart.de

### **France**

SensoPart France Sarl  
662, rue des Jonchères – Bât. A  
F-69730 GENAY  
Phone +33 164 730061  
info@sensopart.fr

### **United Kingdom**

SensoPart UK Limited  
Pera Business Park, Nottingham Road  
Melton Mowbray, Leicestershire  
LE13 0PB  
Phone +44 1664 561539  
info@sensopart.co.uk

### **USA**

SensoPart Inc.  
30600 Telegraph Rd.  
Suite 2345,  
Bingham Farms, MI, 48025  
Phone +1 866 2827610  
usa@sensopart.com

### **China**

SensoPart China  
202, No. 35, Lane 1555  
West Jinshajiang Road,  
Jiading District  
201803 Shanghai  
Phone +86 21 69017660  
china@sensopart.cn

Find your local supplier at: [www.sensopart.com/en/contact/](http://www.sensopart.com/en/contact/)