



IXrouter3

Installation Manual

IX2400 - IXrouter3 Ethernet
IX2405 - IXrouter3 4G/LTE
IX2410 - IXrouter3 Wi-Fi
IX2415 - IXrouter3 4G/LTE & Wi-Fi

1. Contents

| | |
|---|-----------|
| 1. Contents | 1 |
| 2. Introduction | 2 |
| 2.1. Help and support..... | 2 |
| 3. Safety instructions | 3 |
| 3.1. Personnel..... | 3 |
| 3.2. Device..... | 3 |
| 3.3. Application..... | 3 |
| 3.4. Handling..... | 3 |
| 4. Hardware features | 4 |
| 4.1. Technical data..... | 5 |
| 4.1.1. General specifications..... | 5 |
| 4.1.2. Wi-Fi specifications..... | 6 |
| 4.1.3. Cellular specifications..... | 6 |
| 5. Mechanical installation | 6 |
| 5.1. Dimensions..... | 7 |
| 5.2. Mounting and dismounting..... | 8 |
| 6. Electrical installation | 9 |
| 6.1. Instructions for installation..... | 9 |
| 6.2. Mains connection..... | 9 |
| 6.3. Digital input..... | 9 |
| 6.4. Antennas..... | 10 |
| 6.5. Installation..... | 10 |
| 7. SIM card | 11 |
| 7.1. Installation..... | 11 |
| 7.2. Removal..... | 11 |
| 8. Commissioning | 12 |
| 9. Local web interface | 13 |
| 10. Reset to factory default | 14 |
| 11. Connectivity requirements for local IT | 15 |
| 11.1. Overview..... | 15 |
| 11.2. Servers and DNS requests..... | 15 |
| 11.3. MAC or IP address filter..... | 15 |
| 12. Diagnostics and troubleshooting | 16 |
| 13. Compliance | 17 |
| 13.1. European Union..... | 17 |
| 13.2. UL..... | 17 |
| 13.3. FCC..... | 17 |
| 13.4. IC..... | 17 |
| 13.5. ANATEL..... | 17 |
| 13.6. NBTC..... | 18 |
| 13.7. Carrier certifications..... | 18 |

2. Introduction

This installation manual is for the IXrouter3 family of products.

| Model | Description | Ethernet | 4G/LTE | Wi-Fi |
|--------|--------------------------|----------|--------|-------|
| IX2400 | IXrouter3 Ethernet | ✓ | | |
| IX2405 | IXrouter3 4G/LTE | ✓ | ✓ | |
| IX2410 | IXrouter3 Wi-Fi | ✓ | | ✓ |
| IX2415 | IXrouter3 4G/LTE & Wi-Fi | ✓ | ✓ | ✓ |

The IXrouter3 is delivered with the following accessories:

- USB flash drive for configuration
- Female 4-pin plug-in connector with screw connection

2.1. Help and support

For additional product support, installation tips and specifications go to <https://support.ixon.cloud>.

For direct technical support and questions, get in touch with our Technical Support team.

E-mail support@ixon.cloud

Phone **+31 (0)85 744-1105**



⚠ Warning

Read this manual carefully before installing or operating the IXrouter3.

3. Safety instructions

Neglecting the essential safety precautions and safety guidelines outlined below could result in significant harm to individuals and property!

It is crucial to adhere to all the safety instructions and information provided in the relevant product documentation. Doing so is essential for ensuring safe and problem-free operation.

Please pay close attention to the specific safety instructions provided in the other sections of this manual.

3.1. Personnel

Only qualified and skilled personnel are allowed to work with the IXrouter3 and they shall have the following qualifications:

- They are familiar with the installation, mounting, commissioning, and operation of the IXrouter3.
- They possess the appropriate qualifications for their tasks.
- They are familiar with all regulations for the prevention of accidents, directives, and laws applicable at the location and are able to apply them.

3.2. Device

The hardware and software of the IXrouter3 must never be modified in a way that is not described in the installation manual. If you carry out any modifications that are not permitted, all your warranty claims will become null and void. This will result in exclusion of liability on the part of IXON.

3.3. Application

The IXrouter3 is an electrical communication device. It is only suitable for installation in control cabinets or other similar closed operating environments.

3.4. Handling

The IXrouter3 must be handled as follows:

- Connect or disconnect all pluggable terminals only when the IXrouter3 is powered off.
- Only remove the IXrouter3 from the installation when the IXrouter3 is powered off.

4. Hardware features

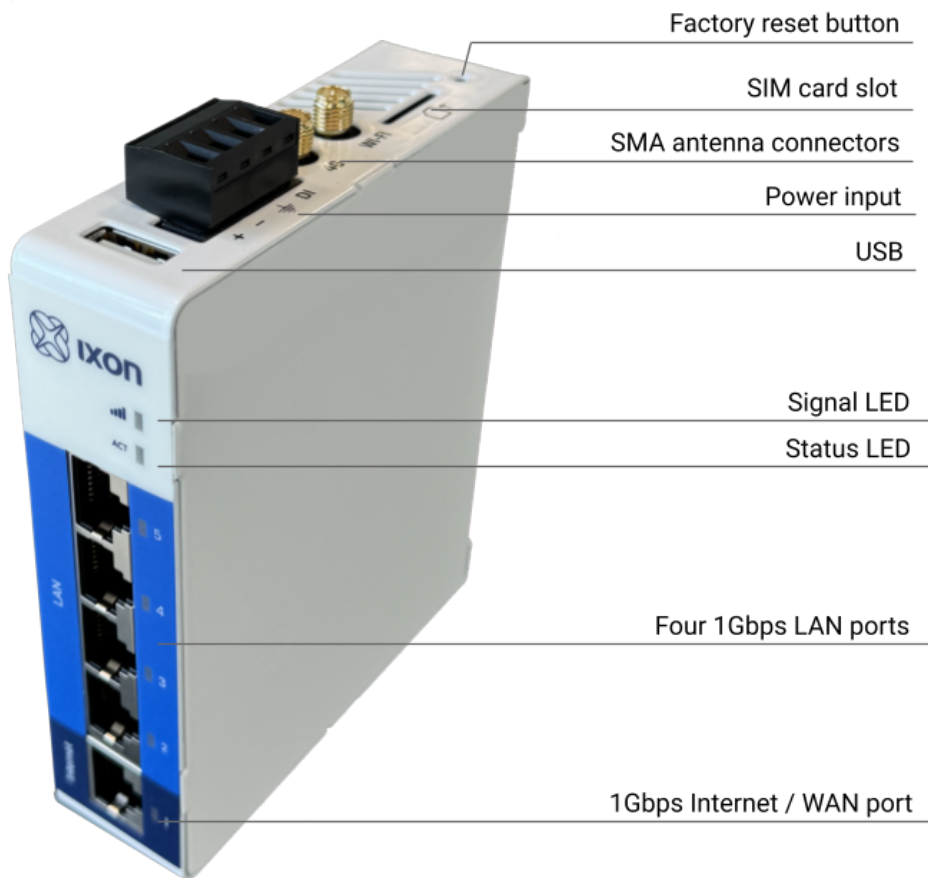

ⓘ Notice

The availability of SMA antenna connectors and a SIM card slot are dependent on the model.

4.1. Technical data

4.1.1. General specifications

| | IX2400 | IX2410 | IX2405 | IX2415 |
|-----------------------|---------------------------------------|----------|----------|----------|
| Power supply | 12-24 VDC +/- 20% ES1, PS2 | | | |
| Rated current | 2A | | | |
| Rated power | 2.5 W | 5 W | 5 W | 5 W |
| Max. power | 10 W | 10 W | 10 W | 10 W |
| Operating temperature | -20°C to 55°C | | | |
| Operating humidity | 10 to 95% non-condensing | | | |
| Operating altitude | Up to a maximum of 2000m | | | |
| Storage temperature | -20°C to 55°C | | | |
| Storage humidity | 10 to 95% non-condensing | | | |
| Storage altitude | Up to a maximum of 3000m | | | |
| Ethernet ports | 4 LAN ports, 1 WAN port. (all 1 Gbps) | | | |
| USB version | USB 2.0 | | | |
| Processor | MIPS 880 MHz | | | |
| Digital Input | 1 | | | |
| Mounting type | DIN rail | | | |
| Size | 95x116x28 mm (excl. DIN rail) | | | |
| Weight | 0.321 kg | 0.324 kg | 0.343 kg | 0.344 kg |

4.1.2. Wi-Fi specifications

| | IX2400 | IX2410 | IX2405 | IX2415 |
|-------------------|--------|--|--------|--|
| Wi-Fi version | - | IEEE 802.11 version b/g/n | - | IEEE 802.11 version b/g/n |
| Wi-Fi modes | - | Station (Client) Mode and Access Point | - | Station (Client) Mode and Access Point |
| Frequency | - | 2.4 GHz | - | 2.4 GHz |
| Speed | - | 72 Mbps | - | 72 Mbps |
| Security protocol | - | WPA2-PSK | - | WPA2-PSK |
| Contains FCC ID | - | XPYLILYW1 | - | XPYLILYW1 |
| Contains IC ID | - | 8595A-LILYW1 | - | 8595A-LILYW1 |

4.1.3. Cellular specifications

| | IX2400 | IX2410 | IX2405 | IX2415 |
|-----------------|--------|--------|--|--------|
| Frequency bands | - | - | LTE-FDD: B1, B2, B3, B4, B5, B7, B8, B12, B13, B18, B19, B20, B25, B26, B28 LTE-TDD: B38, B39, B40, B41 WCDMA: B1, B2, B4, B5, B6, B8, B19 GSM/GPRS/EDGE: B2, B3, B5, B8 | |
| Data rates | - | - | LTE-FDD: Max. 150 Mbps (download) / Max. 50 Mbps (upload) LTE-TDD: Max. 130 Mbps (download) / Max. 30 Mbps (upload) DC-HSPA+: Max. 42 Mbps (download) / Max. 5.76 Mbps (upload) WCDMA: Max. 384 Kbps (download) / Max. 384 Kbps (upload) EDGE: Max. 296 Kbps (download) / Max. 236.8 Kbps (upload) GPRS: Max. 107 Kbps (download) / Max. 85.6 Kbps (upload) | |
| SIM card | - | - | Mini SIM (2FF) | |
| Contains FCC ID | - | - | XMR201903EG25G | |
| Contains IC ID | - | - | 10224A-201903EG25G | |

5. Mechanical installation

5.1. Dimensions

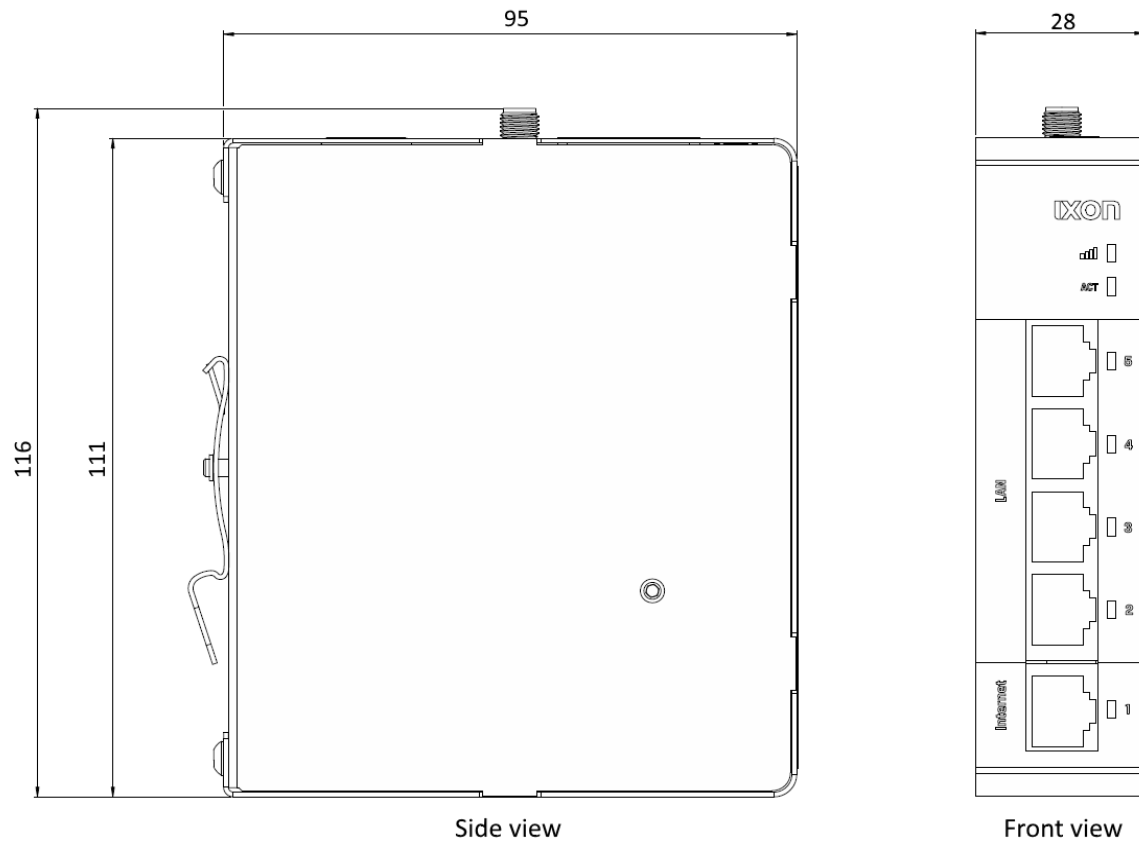

The IXrouter3 is designed to be cooled using natural convection. For proper cooling, you must provide a clearance of at least 25 mm above and below the device. Also, allow at least 25 mm of depth between the front of the device and the inside of the control cabinet.

Warning

The provided installation clearances represent the minimum dimensions required to guarantee adequate air circulation for cooling purposes. However, these dimensions do not take into account the bend radius of the connecting cables and screw-on antennas for devices equipped with Wi-Fi and/or 4G capabilities.

5.2 Mounting and dismounting

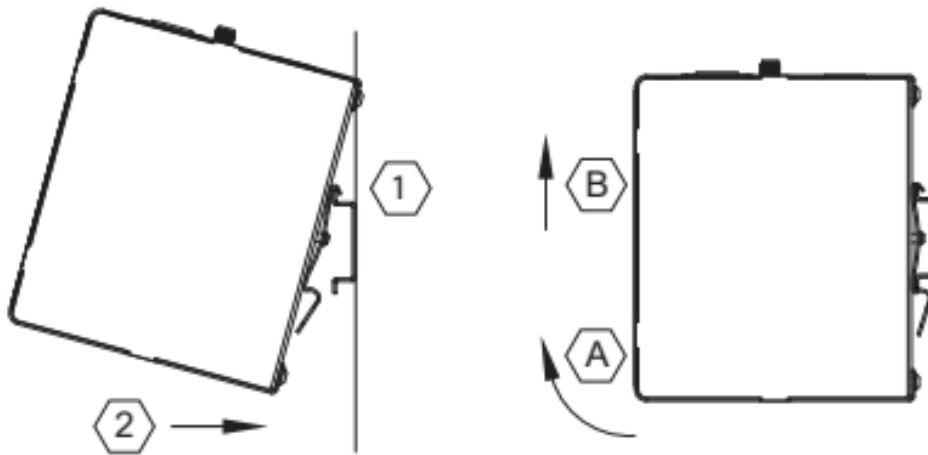

The IXrouter3 is mounted on a standard DIN rail.

(1) Hang the device on the rail and (2) push the unit down until you feel a click. To remove the unit, (A) pull/rotate the device up and (B) lift off the rail.

6. Electrical installation

6.1. Instructions for installation

Consider the following instructions for installation:

- When installing devices in a control cabinet, always separate devices that generate high voltage and high electrical noise from low-voltage, logic-type devices such as the IXrouter3.
- Avoid placing low-voltage signal wires and communications cables in the same tray with AC power wiring and high-energy, rapidly-switched DC wiring.
- Always use an IEC/EN 62368 certified ES1, PS2 power supply for powering the IXrouter3. The output voltage of the power supply must not exceed 29 VDC.
- Always use the included female 4-pin plug-in connector when wiring the IXrouter3.
- Always use twisted pair power cables with a maximum length of 3 m.
- Always use CAT5-S/FTP or higher type shielded cables to ensure a stable LAN connection.
- Always use a shielded USB cable.

6.2. Mains connection

| Mains connection | |
|-----------------------|-------------|
| Wire size range | 18 - 12 AWG |
| Stripping length | 7 mm |
| Tightening torque | 0.4 Nm |
| Max. cable length | 3 m |
| Min. ground conductor | 16 AWG |

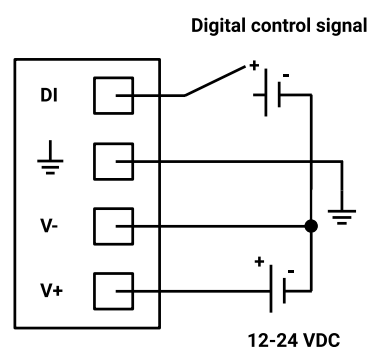

6.3. Digital input

| Digital Input | |
|---------------------|------------|
| Voltage range | 0 - 29 VDC |
| Voltage range (OFF) | 0 - 3 VDC |
| Voltage range (ON) | 7 - 29 VDC |
| Current Voltage | 2 - 5 mA |

By default, the Digital Input is not configured and does not need to be wired. It provides a way to locally control the IXrouter3's VPN connection (ON/OFF). The Digital Input can also be logged in IXON Cloud or trigger an alarm in IXON Cloud. The wiring is depicted in the image above.

6.4. Antennas

This information is only applicable for models IX2405, IX2410 and IX2415.

Warning

Any antennas used with this transmitter must be installed with a minimum separation distance of 20 cm from all persons and must not be co-located or operated in conjunction with any other antennas or transmitters.

6.5. Installation

| Model | Connectors |
|--------|--|
| IX2405 | MAIN: primary connector for SMA cellular antenna. DIV: secondary connector for SMA cellular antenna. Always connect a cellular antenna to the MAIN connector. Connecting an antenna to the DIV connector is optional . |
| IX2410 | WI-FI: connector for RP-SMA Wi-Fi antenna. |
| IX2415 | 4G: connector for cellular SMA antenna. WI-FI: connector for RP-SMA W-Fi antenna. |

Notice

Antennas are not included with the IXrouter3 and can be purchased from IXON separately.

7. SIM card

This information is only applicable for models IX2405 and IX2415.

ⓘ Notice

Only insert or remove the SIM card when the IXrouter3 is powered off.

The SIM card is not included with the IXrouter3 and can be purchased separately from a telecom provider in your region.

The SIM card slot suits a mini SIM card (2FF).

7.1. Installation

To insert the SIM card, gently push it into the slot until you hear a click, which is typically when the SIM card is about 1 mm inserted into the device. Once released, the SIM card will remain securely in the device. Ensure that the side of the SIM card with the golden-colored chip is aligned with the exterior of the enclosure.

7.2. Removal

To remove the SIM card, gently push the SIM card into the slot until you hear a click. Releasing will cause the SIM card to partially eject, allowing you to easily take out the card.

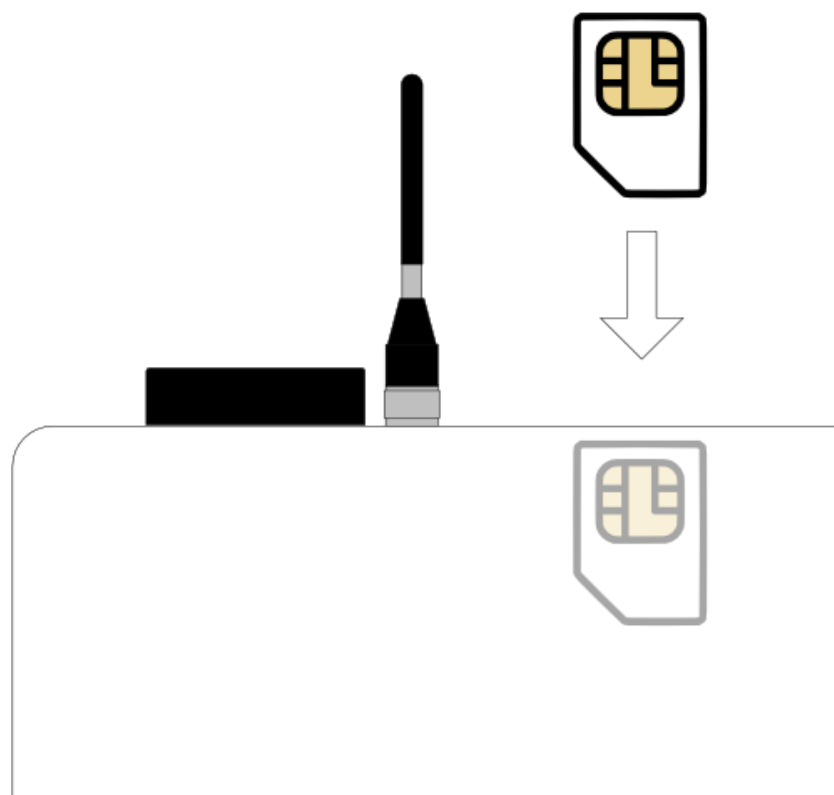

8. Commissioning

ⓘ Notice

Ensure that the mechanical and electrical installation have been completed and that the IXrouter3 is supplied with voltage before commissioning.

Step 1: Create account

Create an account on the IXON Cloud and configure your own IIoT user and company account at portal.ixon.cloud.

Step 2: Create config file

- a. Go to the IXON Cloud Fleet Manager app in your IXON Cloud account.
- b. Open the [Devices] menu and press the “Add new device” button to start the self-explanatory wizard.
- c. Save the downloaded configuration file to the USB flash drive (included) using the exact file name ***router.conf***.

Step 3: Connect

Insert the USB flash drive into the USB port of the IXrouter3. The IXrouter3 will start registering to the IXON Cloud immediately. Once the ACT led status is steady blue, the IXrouter3 is connected to the IXON Cloud and will show up automatically in your company account.

9. Local web interface

The IXrouter3's local web interface can be used to register the router (if it's not already registered in the IXON Cloud), change the WAN, LAN, and Firewall configurations locally or to use the status overview as a more advanced alternative to the LED statuses.

The local web interface can be opened by connecting the IXrouter3 to your computer using one of the router's LAN ports and entering <http://IXrouter3.lan> in your browser. To make changes in the local web interface, enter the password which can be found on the product label on the side of the IXrouter3.

10. Reset to factory default

Warning

After doing a factory reset, the IXrouter3 needs to be re-registered to the IXON Cloud. If the router is still listed in the IXON Cloud and you want to re-use those settings, make sure to turn on **Recovery mode** before registering again.

A factory reset will reset all settings to factory default. This cannot be undone!

The IXrouter3 can be reset to factory default settings by pressing and holding the reset button on top for 5 seconds. The ACT LED will start blinking shortly after the reset button is pressed. Hold the button down until the LEDs stop flashing, then release it. Wait for the IXrouter3 to restart, this can take up to 2 minutes. You can now reconfigure the IXrouter3.

11. Connectivity requirements for local IT

The IXrouter3 uses outgoing ports to establish a secure connection to the IXON Cloud. This means there is no need to open any incoming ports in your firewall.

11.1. Overview

Below is an overview of the outgoing ports and protocols that the IXrouter3 utilizes.

| Direction | Port | Transport | Application |
|-----------|--------------------------|---------------------|--|
| Outbound | 443 | TCP | HTTPS, MQTT (TLS) OpenVPN ⁽¹⁾ |
| Outbound | 1194 ⁽²⁾ | UDP | OpenVPN |
| Outbound | 8443 ⁽³⁾ | TCP | HTTPS |
| Outbound | 53 ⁽⁴⁾ | TCP & UDP | DNS |
| Outbound | (no port) ⁽⁵⁾ | ICMP (Echo request) | - |

- (1) The very first package may be considered unencrypted as the OpenVPN handshake takes place prior to the TLS handshake.
For this reason an exception may be required on firewall rules that block non-SSL traffic over SSL-ports.
- (2) Only used when the VPN connection type is set to UDP.
- (3) Only used when stealth mode is activated for connectivity via a censored internet connection (i.e. when located in China).
- (4) DNS requests are often handled by local DNS servers. In those cases the listed DNS port can be ignored.
- (5) Only used when failover is configured.

11.2. Servers and DNS requests

The IXrouter3 connects to different IXON servers: REST API, MQTT, and OpenVPN servers, which include the following domains: .ixon.cloud; .ixon.net; .ayayot.com (phonetic IIoT).









Doing a DNS lookup (nslookup) at the following domain name always returns an up-to-date IP list of all current IXON servers: whitelist.ixon.cloud

11.3. MAC or IP address filter





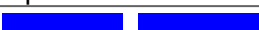
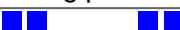



Internet access may be granted to specific devices, based on their MAC or IP addresses. The IXrouter3's MAC address can be obtained from the label on the side of the IXrouter3. The IP address can be set to a static IP address. However, by default the IP address is set to be assigned dynamically via DHCP.

12. Diagnostics and troubleshooting

The status LED indicator (ACT) is located directly above the LAN ports and shows the current status of the IXrouter3.

| Status LED (ACT) | Status/meaning |
|---|--|
|  Constant | Booting up (may take 1-2 min) or not yet registered |
|  1 pulse | Waiting for internet access |
|  3 pulses | LAN/WAN conflict (conflicting subnets) |
|  4 pulses | Removed from the IXON Cloud (re-insert USB flash drive to register again) |
|  5 pulses | Previously registered to the IXON Cloud (remove from the IXON Cloud and register again) |
|  1 pulse | Connecting to the IXON Cloud |
|  1 long pulse | VPN is manually disabled |
|  2 pulses | Setting up a VPN connection |
|  Constant | Active VPN connection to the IXON Cloud |

The signal LED indicator is only available for models IX2405, IX2410 and IX2415 and shows information on reception.

| Signal LED | Status/meaning |
|---|---|
|  Blinking | Initializing cellular module |
|  1 pulse | No reception or unable to connect to network (APN or SSID may be incorrect) |
|  1 pulse | No reception or unable to connect to network (APN or SSID may be incorrect) |
|  2 pulses | Firmware 3.22 or higher: PIN invalid Firmware 3.21.1 or lower: PIN invalid or PUK required |
|  3 pulses | PUK required (a phone is required to unlock SIM card with PUK) |
|  4 pulses | SIM card is invalid or missing |
|  Constant | Connected, poor reception |
|  Constant | Connected, medium reception |
|  Constant | Connected, good reception |

13. Compliance

13.1. European Union

Hereby, IXON B.V. declares that the radio equipment type IXrouter3 is in compliance with Directive 2014/53/EU. The full text of the EU declaration of conformity is available at the following internet address: <https://www.ixon.cloud/ce-declaration-of-conformity>.

13.2. UL

This device is UL listed for USA and Canada under file number E492721.

13.3. FCC

This device complies with Part 15 of the FCC Rules. Operation is subject to the following two conditions:

- This device may not cause harmful interference, and
- This device must accept any interference received, including interference that may cause undesired operation.

13.4. IC

This device complies with Industry Canada licence-exempt RSS standard(s). Operation is subject to the following two conditions:

- this device may not cause interference, and
- this device must accept any interference, including interference that may cause undesired operation of the device.

Son utilisation est soumise aux deux conditions suivantes:

- Cet appareil ne doit pas causer d'interférences et
- il doit accepter toutes interférences reçues, y compris celles susceptibles d'avoir des effets indésirables sur son fonctionnement.

13.5. ANATEL

Para maiores informações, consulte o site da ANATEL www.gov.br/anatel/pt-br/.

Este equipamento não tem direito à proteção contra interferência prejudicial e não pode causar interferência em sistemas devidamente autorizados.

13.6. NBTC

เครื่องโทรคมนาคมและอุปกรณ์นี้ มีความสอดคล้องตามมาตรฐานหรือข้อกำหนดทางเทคนิคของ กสทช.

เครื่องวิทยุคมนาคมนี้ มีระดับการแผ่คลื่นแม่เหล็กไฟฟ้าสอดคล้องตามมาตรฐาน ความปลอดภัยต่อสุขภาพของมนุษย์จากการใช้เครื่องวิทยุคมนาคมที่คณะกรรมการกิจการโทรคมนาคมแห่งชาติประกาศกำหนด



13.7. Carrier certifications

The IXrouter3 4G routers have additionally been certified by the following carriers:

- Verizon
- AT&T



Thanks for choosing us! We're dedicated to providing you with a reliable solution for seamless machine connectivity.

If you have any questions or concerns, please don't hesitate to reach out to us.

IXON B.V.
Zuster Bloemstraat 20
5835 DW Beugen
The Netherlands