

Hangzhou Hikrobot Technology Co.,Ltd.

SC3000X Series Vision Sensor

Quick Start Guide

HIKROBOT

Legal Information

©2024 Hangzhou Hikrobot Co., Ltd. All rights reserved.

About this Manual

The document includes instructions for using and managing the product. Pictures, charts, images and all other information hereinafter are for description and explanation only. The information contained in the document is subject to change, without notice, due to firmware updates or other reasons. Please find the latest version in the company website (<https://en.hikrobotics.com/>). Unless otherwise agreed, Hangzhou Hikrobot Co., Ltd. or its affiliates (hereinafter referred to as "Hikrobot") makes no warranties, express or implied. Please use the Document with the guidance and assistance of professionals trained in supporting the Product.

Acknowledgment of Intellectual Property Rights

Hikrobot owns the copyrights and/or patents related to the technology embodied in the Products described in this Document, which may include licenses obtained from third parties. Any part of the Document, including text, pictures, graphics, etc., belongs to Hikrobot. No part of this Document may be excerpted, copied, translated, or modified in whole or in part by any means without written permission.

HIKROBOT and other Hikrobot's trademarks and logos are the properties of Hikrobot in various jurisdictions. Other trademarks and logos mentioned are the properties of their respective owners.

Disclaimer

TO THE MAXIMUM EXTENT PERMITTED BY APPLICABLE LAW, THIS MANUAL AND THE PRODUCT DESCRIBED, WITH ITS HARDWARE, SOFTWARE AND FIRMWARE, ARE PROVIDED "AS IS" AND "WITH ALL FAULTS AND ERRORS". HIKROBOT MAKES NO WARRANTIES, EXPRESS OR IMPLIED, INCLUDING WITHOUT LIMITATION, MERCHANTABILITY, SATISFACTORY QUALITY, OR FITNESS FOR A PARTICULAR PURPOSE. THE USE OF THE PRODUCT BY YOU IS AT YOUR OWN RISK. IN NO EVENT WILL HIKROBOT BE LIABLE TO YOU FOR ANY SPECIAL, CONSEQUENTIAL, INCIDENTAL, OR INDIRECT DAMAGES, INCLUDING, AMONG OTHERS, DAMAGES FOR LOSS OF BUSINESS PROFITS, BUSINESS INTERRUPTION, OR LOSS OF DATA, CORRUPTION OF SYSTEMS, OR LOSS OF DOCUMENTATION, WHETHER BASED ON BREACH OF CONTRACT, TORT (INCLUDING NEGLIGENCE), PRODUCT LIABILITY, OR OTHERWISE, IN CONNECTION WITH THE USE OF THE PRODUCT, EVEN IF HIKROBOT HAS BEEN ADVISED OF THE POSSIBILITY OF SUCH DAMAGES OR LOSS.

YOU ACKNOWLEDGE THAT THE NATURE OF INTERNET PROVIDES FOR INHERENT SECURITY RISKS, AND HIKROBOT SHALL NOT TAKE ANY RESPONSIBILITIES FOR ABNORMAL OPERATION, PRIVACY LEAKAGE OR OTHER DAMAGES RESULTING FROM CYBER-ATTACK, HACKER ATTACK, VIRUS INFECTION, OR OTHER INTERNET SECURITY RISKS; HOWEVER, HIKROBOT WILL PROVIDE TIMELY TECHNICAL SUPPORT IF REQUIRED. YOU AGREE TO USE THIS PRODUCT IN COMPLIANCE WITH ALL APPLICABLE LAWS, AND YOU ARE SOLELY RESPONSIBLE FOR ENSURING THAT YOUR USE CONFORMS TO THE

APPLICABLE LAW. ESPECIALLY, YOU ARE RESPONSIBLE, FOR USING THIS PRODUCT IN A MANNER THAT DOES NOT INFRINGE ON THE RIGHTS OF THIRD PARTIES, INCLUDING WITHOUT LIMITATION, RIGHTS OF PUBLICITY, INTELLECTUAL PROPERTY RIGHTS, OR DATA PROTECTION AND OTHER PRIVACY RIGHTS. YOU SHALL NOT USE THIS PRODUCT FOR ANY PROHIBITED END-USES, INCLUDING THE DEVELOPMENT OR PRODUCTION OF WEAPONS OF MASS DESTRUCTION, THE DEVELOPMENT OR PRODUCTION OF CHEMICAL OR BIOLOGICAL WEAPONS, ANY ACTIVITIES IN THE CONTEXT RELATED TO ANY NUCLEAR EXPLOSIVE OR UNSAFE NUCLEAR FUEL-CYCLE, OR IN SUPPORT OF HUMAN RIGHTS ABUSES.

THE PERFORMANCE DATA IN THIS PUBLICATION IS BASED ON HIKROBOT'S INTERNAL RESEARCH/EVALUATION. ACTUAL DATA MAY VARY DEPENDING ON SPECIFIC CONFIGURATIONS AND OPERATING CONDITIONS AND HIKROBOT SHALL NOT BEAR THE CONSEQUENCES ARISING THEREFROM. IN THE EVENT OF ANY CONFLICTS BETWEEN THIS MANUAL AND THE APPLICABLE LAW, THE LATTER PREVAILS.

Regulatory Information

EU Conformity Statement



This product and - if applicable - the supplied accessories too are marked with "CE" and comply therefore with the applicable harmonized European standards listed under the Directive 2014/30/EU (EMCD), Directive 2001/95/EC (GPSD) and Directive 2011/65/EU (RoHS).



2012/19/EU (WEEE directive): Products marked with this symbol cannot be disposed of as unsorted municipal waste in the European Union. For proper recycling, return this product to your local supplier upon the purchase of equivalent new equipment, or dispose of it at designated collection points. For more information see: <http://www.recyclethis.info>



2006/66/EC (battery directive): This product contains a battery that cannot be disposed of as unsorted municipal waste in the European Union. See the product documentation for specific battery information. The battery is marked with this symbol, which may include lettering to indicate cadmium (Cd), lead (Pb), or mercury (Hg). For proper recycling, return the battery to your supplier or to a designated collection point. For more information see: <http://www.recyclethis.info>

This is a class A product. In a domestic environment this product may cause radio interference in which case the user may be required to take adequate measures.



KC Mark Certification

Class A: The device is advised to note that as a seller or a business user (Class A) Devices and intended for use outside the Home area.

A급 기기: 이 기기는 업무용(A급) 전자파적합기기로서 판매자 또는 사용자는 이 점을 주의하시기바라며, 가정 외의 지역에서 사용하는 것을 목적으로 합니다.

Symbol Conventions

The symbols that may be found in this document are defined as follows.

Symbol	Description
 Danger	Indicates a hazard with a high level of risk, which if not avoided, will result in death or serious injury.
 Caution	Indicates a potentially hazardous situation which, if not avoided, could result in equipment damage, data loss, performance degradation, or unexpected results.
 Note	Provides additional information to emphasize or supplement important points of the main text.

Available Model

This manual is applicable to the SC3000X series vision sensor.

Contact Information

Hangzhou Hikrobot Co., Ltd.

E-mail: global.support@hikrobotics.com

Website: <https://en.hikrobotics.com/>

Contents

Chapter 1 Safety Instruction	1
1.1 Safety Claim	1
1.2 Safety Instruction	1
1.3 Electromagnetic Interference Prevention.....	3
Chapter 2 Overview.....	5
2.1 Introduction.....	5
2.2 Key Feature.....	5
Chapter 3 Appearance	6
Chapter 4 12-Pin Connector and Indicator	8
4.1 12-Pin Connector	8
4.2 Indicator.....	9
Chapter 5 Device Installation and Wiring.....	10
5.1 Installation Preparation.....	10
5.2 Install Device.....	11
5.3 Wire Device.....	12
Chapter 6 Device Debugging	14
6.1 Set PC Network.....	14
6.2 Install Client Software	15
6.3 Set Device Network.....	16
6.4 Login.....	17
Chapter 7 Client Layout and Operation Flow.....	18
7.1 Main Window Introduction.....	18
7.2 Operation Flow	19
Chapter 8 I/O and Serial Port	20
8.1 I/O Electrical Feature	20
8.1.1 Input Signal.....	20
8.1.2 Output Signal.....	21
8.2 I/O Wiring.....	22
8.2.1 Input Signal Wiring	22

8.2.2 Output Signal Wiring	23
8.3 RS-232 Serial Port	24
8.3.1 RS-232 Serial Port Introduction	24
8.3.2 RS-232 Serial Port Wiring	25
Chapter 9 FAQ (Frequently Asked Question)	26
9.1 Why there is no device listed after I run the client software?	26
9.2 Why the image is very dark?	26
9.3 Why the image's frame rate is very low in the live view?	26
9.4 Why there is no image in the live view?	27

Chapter 1 Safety Instruction

The safety instructions are intended to ensure that the user can use the device correctly to avoid danger or property loss. Read and follow these safety instructions before installing, operating and maintaining the device.

1.1 Safety Claim

- To ensure personal and device safety, when installing, operating, and maintaining the device, follow the signs on the device and all safety instructions described in the manual.
- The note, caution and danger items in the manual do not represent all the safety instructions that should be observed, but only serve as a supplement to all the safety instructions.
- The device should be used in an environment that meets the design specifications, otherwise it may cause malfunctions, and malfunctions or component damage caused by non-compliance with relevant regulations are not within the scope of the device's quality assurance.
- Our company will not bear any legal responsibility for personal safety accidents and property losses caused by abnormal operation of the device.

1.2 Safety Instruction



Caution

- Do not install the device if it is found that the device and accessories are damaged, rusted, water ingress, model mismatch, missing parts, etc., when unpacking.
- Avoid storage and transportation in places such as water splashing and rain, direct sunlight, strong electric fields, strong magnetic fields, and strong vibrations.
- Avoid dropping, smashing or vigorously vibrating the device and its components.
- It is forbidden to install the indoor device in an environment where it may be exposed to water or other liquids. If the device is damp, it may cause fire and electric shock hazard.
- Place the device in a place out of direct sunlight and ventilation, away from heat sources such as heaters and radiators.
- This is a class A product. In a domestic environment this product may cause radio interference in which case the user may be required to take adequate measures.
- In the use of the device, you must be in strict compliance with the electrical safety regulations of the nation and region.
- Use the power adapter provided by the official manufacturer. The power adapter must meet the Limited Power Source (LPS) requirements. For specific requirements, please refer to the device's technical specifications.
- It is strictly forbidden to wire, maintain, and disassemble the device is powered on. Otherwise, there is a danger of electric shock.

SC3000X Series Vision Sensor Quick Start Guide

- Before powering on the device, please confirm that the device is installed in good condition, the wiring is firm, and the power supply meets the requirements.
- This device is not suitable for use in places where children may appear.
- Using the wrong type of battery replacement (for example, some types of lithium batteries) may cause the safety protection to fail.
- Do not throw the battery into a fire or heating furnace, do not squeeze, bend or cut the battery, which may cause an explosion.
- Do not place the battery in an extremely high temperature or low pressure environment, which may cause the battery to explode or leak flammable liquids or gases.
- Waste batteries can cause pollution to the environment, please follow the instructions to dispose of the used batteries.
- If the device emits smoke, odor or noise, please turn off the power and unplug the power cord immediately, and contact the dealer or service center in time.
- It is strictly forbidden to touch any terminal of the device when operating it. Otherwise there is a danger of electric shock.
- It is strictly forbidden for non-professional technicians to detect signals during device operation, otherwise it may cause personal injury or device damage.
- It is strictly forbidden to maintain the device is powered on, otherwise there is a danger of electric shock.
- Avoid aiming the lens at strong light such as lighting, sunlight, or laser beams, etc., otherwise the image sensor will be damaged.
- It is forbidden to touch the image sensor directly. If necessary, please moisten a soft clean cloth with 75% or less alcohol and gently wipe off the dust. When the device is not in use, please add a dust cover to protect the image sensor.
- Keep clean of the device's image acquisition window. It is recommended to use cleaning water to wipe off the dust.
- If the device does not work properly, please contact your dealer or the nearest service center. Never attempt to disassemble the device yourself. We shall not assume any responsibility for problems caused by unauthorized repair or maintenance.
- Caution: If the device has battery, risk of explosion if battery is replaced by an incorrect type. Dispose of used batteries according to the instructions.
- Please dispose of the device in strict accordance with the relevant national or regional regulations and standards to avoid environmental pollution and property damage.

Note

- Check whether the device's package is in good condition, whether there is damage, intrusion, moisture, deformation, etc. before unpacking.
- Check the surface of the device and accessories for damage, rust, bumps, etc. when unpacking.
- Check whether the quantity and information of the device and accessories are complete after unpacking.
- Store and transport the device according to the storage and transport conditions of the device, and the storage temperature and humidity should meet the requirements.
- It is strictly prohibited to transport the device in combination with items that may affect or damage the device.

- The device should not be placed with exposed flame sources, such as lighted candles.
- Please read the manual and safety instructions carefully before installing the device.
- Quality requirements for installation and maintenance personnel:
 - Qualification certificate or working experience in weak current system installation and maintenance, and relevant working experience and qualifications. Besides, the personnel must possess the following knowledge and operation skills.
 - The basic knowledge and operation skills of low voltage wiring and low voltage electronic circuit connection.
 - The ability to comprehend the contents of this manual.

1.3 Electromagnetic Interference Prevention

- Make sure that the shielding layer of cables is intact and 360° connected to the metal connector when using shielded cables.
- Do not route the device together with other equipment (especially servo motors, high-power devices, etc.), and control the distance between cables to more than 10 cm. Make sure to shield the cables if unavoidable.
- The control cable of the device and the power cable of the industrial light source must be wired separately to avoid bundled wiring.
- The power cable, data cable, signal cable, etc. of the device must be wired separately. Make sure to ground them if the wiring groove is used to separate the wiring and the wiring groove is metal.
- During the wiring process, evaluate the wiring space reasonably, and do not pull the cables hard, so as not to damage the electrical performance of the cables.
- If the device is powered on and off frequently, it is necessary to strengthen the voltage isolation, and consider adding a DC/DC isolation power supply module between the device and the adapter.
- Use the power adapter to supply power to the device separately. If centralized power supply is necessary, make sure to use a DC filter to filter the power supply of the device separately before use.
- The unused cables of the device must be insulated.
- When installing the device, if you cannot ensure that the device itself and all equipment connected to the device are well grounded, you should isolate the device with an insulating bracket.
- To avoid the accumulation of static electricity, ensure that other equipment (such as machines, internal components, etc.) and metal brackets on site are properly grounded.
- Make sure that the connector metal barrier of the device is well connected to the PC and other chassis, and if necessary, copper foil should be used to enhance the grounding effect.
- During the installation and use of the device, high voltage leakage must be avoided.
- Use a figure-eight bundle method if the device cable is too long.
- When connecting the device and metal accessories, they must be connected firmly to maintain good conductivity.
- Use a shielded network cable to connect to the device. If you use a self-made network

SC3000X Series Vision Sensor Quick Start Guide

cable, make sure that the shielding shell at the aviation head is well connected to the aluminum foil or metal braid of the shielding cable.

Chapter 2 Overview

2.1 Introduction

The vision sensor mentioned in this manual integrates functions of image acquisition, image processing and result output, and is used in machine vision inspection. The device uses image sensors and optical elements to obtain the image of the measured object, realizes the functions of counting, existence, measurement and recognition via the built-in algorithms, and can output the detection results through a variety of communication methods. With the client software, the device can quickly build the project and finish related configurations, and it is easy to use, widely used in the industrial field.

2.2 Key Feature

- Adopts embedded hardware platform to realize high-speed image processing.
- Built-in high-precision positioning, measurement and recognition algorithms for counting, defects, existence, positioning and other functions.
- Supports RS-232, TCP, UDP, FTP, ModBus, PROFINET, EtherNet/IP and other communication modes.
- Adopts multiple IO interfaces for input and output signals.
- Supports viewing the device's status in real time via 360 ° visual indicator, convenient for debugging and maintenance.
- Rotatable cable tail design, suitable for narrow space.
- Adopts polarized, diffused, and full-transparent multiple optical lighting with good environmental adaptability.
- IP67 protection without fear of harsh industrial application environments.

Note

- The specific functions may differ by device models.
 - Refer to the device's datasheet for specific parameters.
-

Chapter 3 Appearance

Note

Appearance here is for reference only. Refer to the device's datasheet for detailed dimension information.

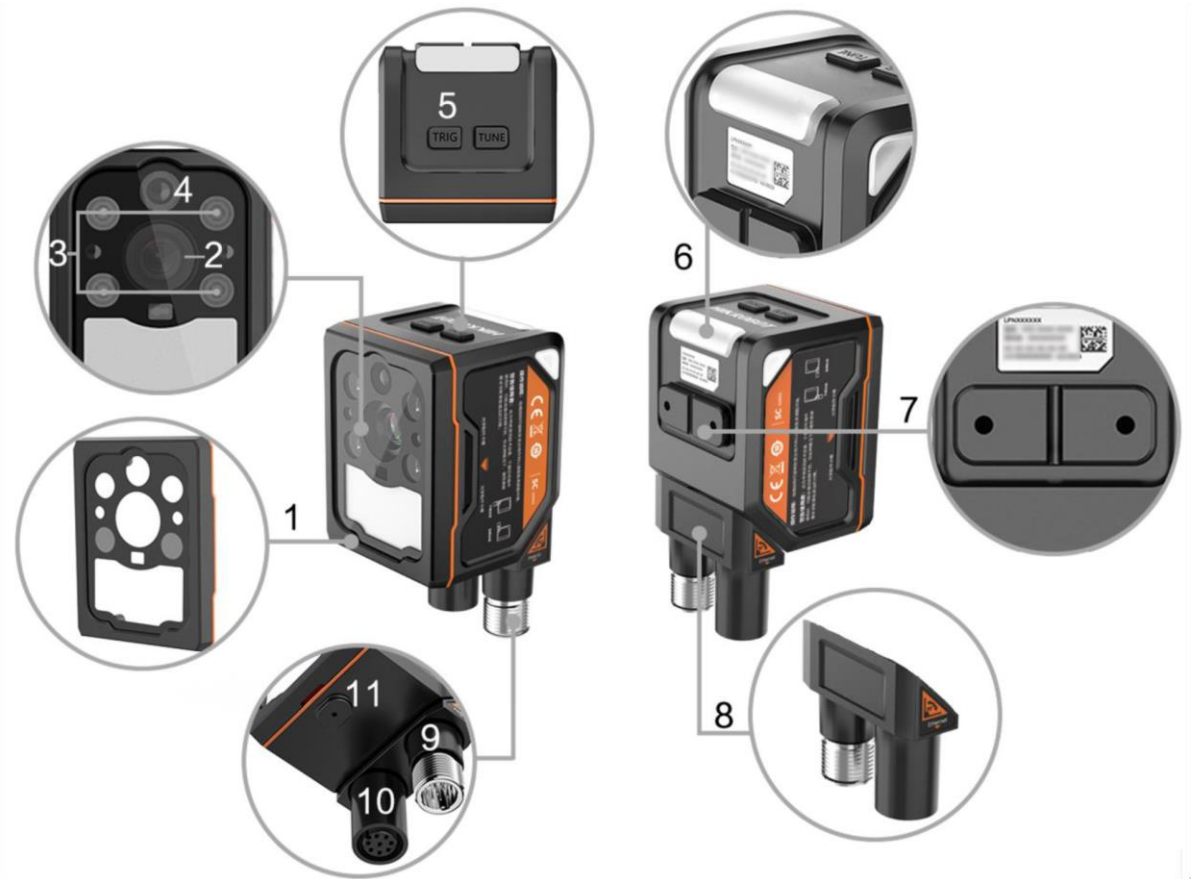



Figure 3-1 Appearance

Table 3-1 Component Description

No.	Name	Description
1	Lens Cap	<p>The device adopts polarized + diffused + full-transparent lens cap, which can easily adapt to environmental changes and ensure the stability of image processing.</p> <p>Note It can be replaced with other lens cap according to actual demands.</p>

SC3000X Series Vision Sensor Quick Start Guide

No.	Name	Description
2	Image Sensor	It is used to acquire images.
3	Light Source	It is the white point light source × 4 and white diffused light source × 18 by default, which is used to provide light when the device acquires images.  Note The red/blue/IR light source is optional.
4	Aiming System	It is orange LED light used to show the field of view and aim targets.
5	Trigger Button	It is used to trigger the device via pressing the button. If the device is in trigger mode, press the button and the device triggers once.
6	Device Indicator	It is a 360 ° visible indicator for observing the device's status.
7	Rear Screw Hole	It is used to fix the device, and you should use M3 screws.
8	Right Angle Rotation Structure	It is used to rotate the device's cables.
9	12-Pin Connector	It provides power supply, I/O, and RS-232 signals.
10	Network Interface	It is fast Ethernet for transmitting data.
11	Bottom Screw Hole	It is used to connect protective cover, and you should use M3 screws.

Chapter 4 12-Pin Connector and Indicator

4.1 12-Pin Connector

Read the following section to get pin definitions of 12-pin connector.

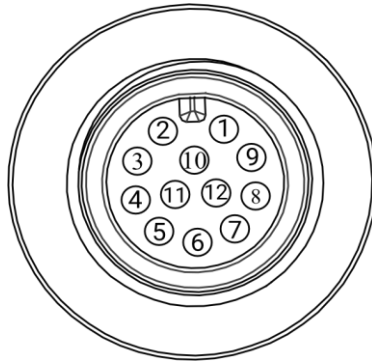

Figure 4-1 12-Pin Connector

Table 4-1 Pin Definitions

No.	Signal	I/O Signal Source	Description	Cable Color
1	DC-PWR	--	Direct current power supply positive	White
2	GND	--	Power supply ground	Brown
3	LINE 3	LINE 3 output signal line	I/O isolated output 3	Green
4	LINE 4	LINE 4 output signal line	I/O isolated output 4	Yellow
5	LINE 5	LINE 5 output signal line	I/O isolated output 5	Gray
6	OUT_COM	LINE 3/4/5 output signal ground	Output common port	Pink
7	LINE 0	LINE 0 input signal line	I/O isolated input 0	Blue
8	LINE 1	LINE 1 input signal line	I/O isolated input 1	Red
9	LINE 2	LINE 2 input signal line	I/O isolated input 2	Black
10	IN_COM	LINE 0/1/2 input signal ground	Input common port	Purple
11	RS-232_R	--	RS232 input	Gray/Pink
12	RS-232_T	--	RS232 output	Red/Blue

 **Note**

You should refer to the table above and the label attached to the supplied power and I/O cable to wire the device.

4.2 Indicator

You can observe the device's indicator to check whether the device operates normally or not.

Table 4-2 Indicator Description

Device Status		Indicator Status
Power Off Status		Unlit
Non-Streaming Status		Solid Yellow
Streaming Status	Project Result OK	Solid Green
	Project Result NG	Solid Red

Chapter 5 Device Installation and Wiring

5.1 Installation Preparation

You need to prepare following accessories before installation. The included accessories are in the device's package, and you can purchase optional accessories according to actual demands.

Table 5-1 Included Accessories











No.	Name	Picture	Quantity	Description
1	Power and I/O Cable		1	It refers to the 3-meter 12-pin M12 to open cable.
2	M12 Network Cable		1	It refers to the 3-meter M12 to RJ45 network cable.
3	Installation Bracket		1	It is used to fix the device.
4	Lens Cap		1	The device has a polarized + diffused + full-transparent lens cap by default. Note It can be replaced with other lens cap according to actual demands.
5	Light Board		1	The device has a light board integrating white point light source × 4 and white diffused light source × 18 by default. Note It can be replaced with red/blue/IR light board.

Table 5-2 Optional Accessories

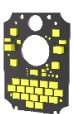
No.	Name	Picture	Quantity	Description
1	Power Adapter		1	You should select suitable power adapter or switch power supply according to the device power supply and consumption.

No.	Name	Picture	Quantity	Description
2	ESD Protective Cover		1	It is used to achieve ESD protection.
3	Diffuser Cover		1	It is used to suppress background interference.
4	YAG Protective Cover		1	It is used to avoid YAG laser.
5	Power and I/O Cable		1	You can purchase flexible or different-length 12-pin M12 to open cable according to actual demands.
6	M12 Network Cable		1	You can purchase flexible or different-length M12 to RJ45 network cable according to actual demands.

5.2 Install Device

Before You Start

- Make sure the device in the package is in good condition and all the assembly parts are included.
- Make sure that all the related devices are powered off during the installation.

Steps

1. Select a suitable installation location according to the device's field of view.

Note

Refer to the device's datasheet for its FoV and installation range.

2. Adjust the device's right angle rotation structure according to the installation location.

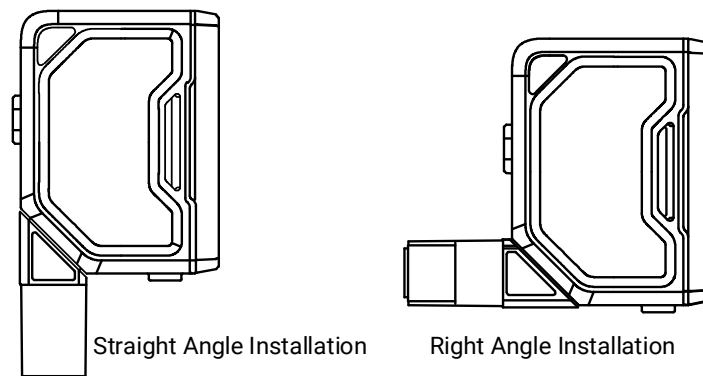

Figure 5-1 Adjust Right Angle Rotation Structure

Note

Refer to the device's datasheet for the dimension of the right angle rotation structure.

3. Use M3 screws to fix the installation bracket to the device, as shown below.

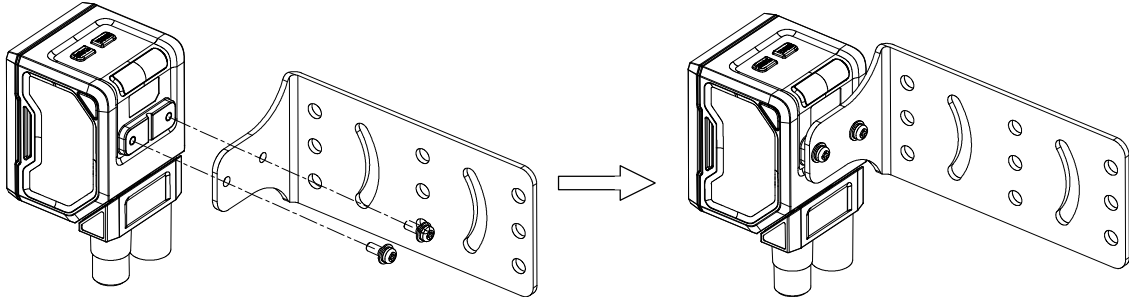

Figure 5-2 Fix Installation Bracket

4. Install the device to the installation location via the bracket.

5.3 Wire Device

After installing the device, you should connect the device to a network cable for image debugging and data communication, and connect the device to a power and I/O cable for power supply.

Steps

1. Use the supplied M12 network cable to connect the device's network interface.

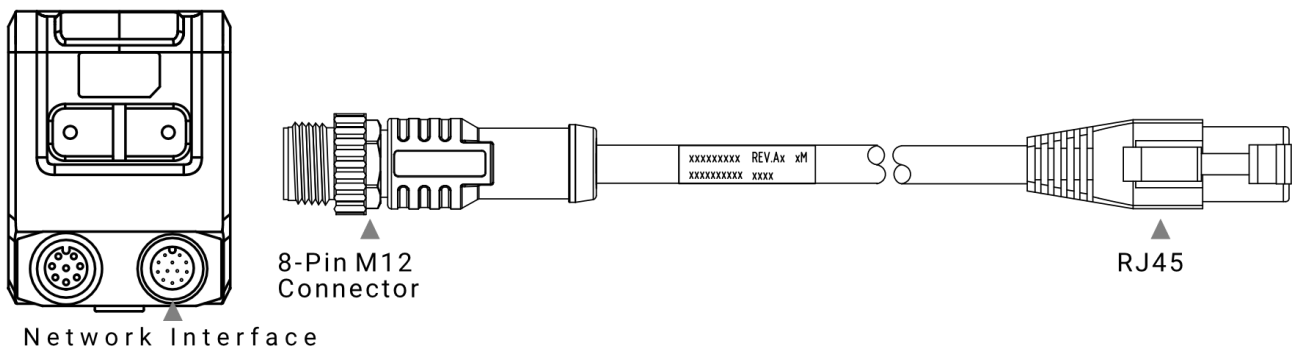

Figure 5-3 Connect Device's Network Interface

Note

The 8-pin M12 connector has screw thread, and it is recommended to tighten the connector before using the device to reduce looseness due to the vibration on-site.

- 2. Insert the RJ45 port of the supplied M12 network cable to the PC.
- 3. Use the supplied power and I/O cable to connect the device's 12-pin connector.

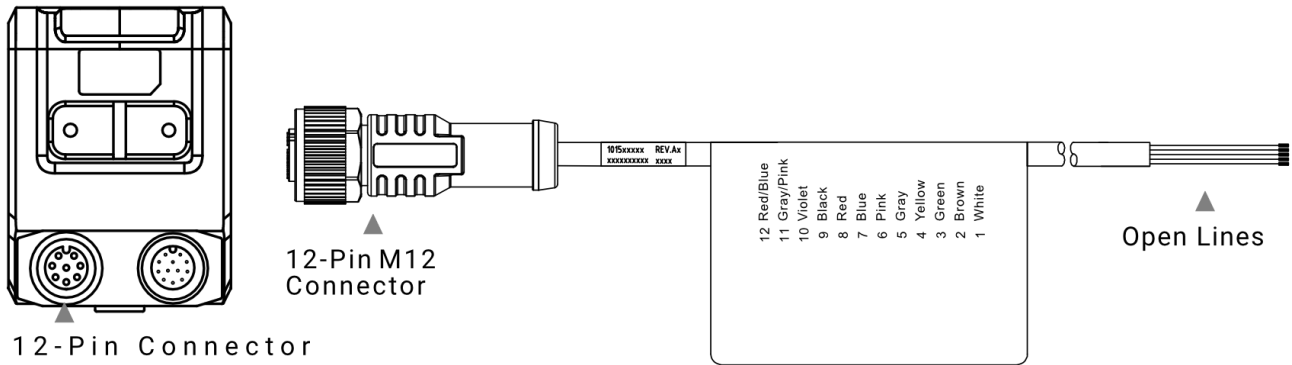

Figure 5-4 Connect Device's 12-Pin Connector

Note

The 12-pin M12 connector has screw thread, and it is recommended to tighten the connector before using the device to reduce looseness due to the vibration on-site.

4. Select suitable power adapter to connect the open lines of the supplied power and I/O cable for power supply.

Note

- The device's indicator is solid yellow after powering on the device without streaming.
- Refer to the pin definitions of the 12-pin connector for specific color of open lines.

Chapter 6 Device Debugging

Before debugging the device, you need to set the PC's network, install the client software and log into the device.

6.1 Set PC Network

To ensure stable image transmission and normal communication between the PC and the device via client software, you need to set the PC network before using the client software.

Steps

Note

For different Windows versions, the specific setting path and interface may differ. Please refer to the actual condition.

1. Go to PC network settings page: **Start** → **Control Panel** → **Network and Internet** → **Network and Sharing Center** → **Change adapter settings**.
2. Select NIC and set the IP obtainment mode.
 - Select **Obtain an IP address automatically** to get an IP address of the PC automatically.
 - Or select **Use the following IP address** to set an IP address for the PC manually.

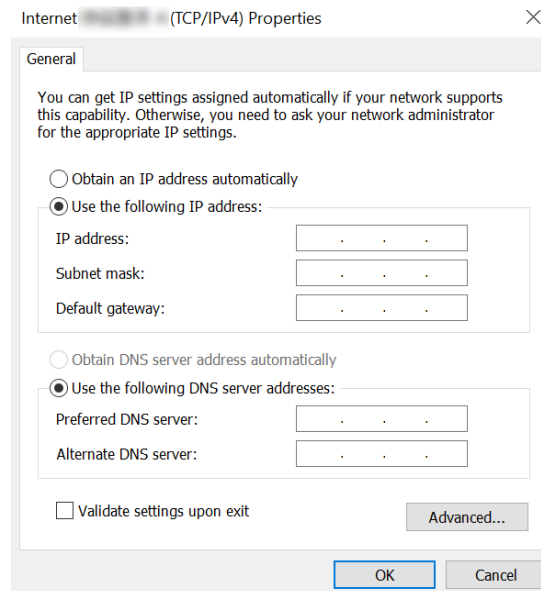

Figure 6-1 Set PC Network

Note

It is recommended to use the static IP address to reduce time for searching the device.

3. Set NIC property.

- 1) Go to NIC settings page: **Control Panel** → **Hardware and Sound** → **Device Manager** → **Network Adapter**.
- 2) Select corresponding network interface card, and click **Advanced**.
- 3) Set **Speed and Duplex** as **Auto-Negotiation** or **100 Mbps**.

6.2 Install Client Software

SCMVS is a client software for device configuration and remote operations.

Note

- Check the Windows version. The client software is compatible with 32/64-bit Windows 7/10.
 - You can get the client software installation package from <https://en.hikrobotics.com/>.
 - The graphic user interface may differ by different versions of client software you use.
-

Steps

1. Double click the installation package to install the client software.
2. Select the language.
3. Read and check **Terms of the License Agreement**.
4. Click **Start Setup**.

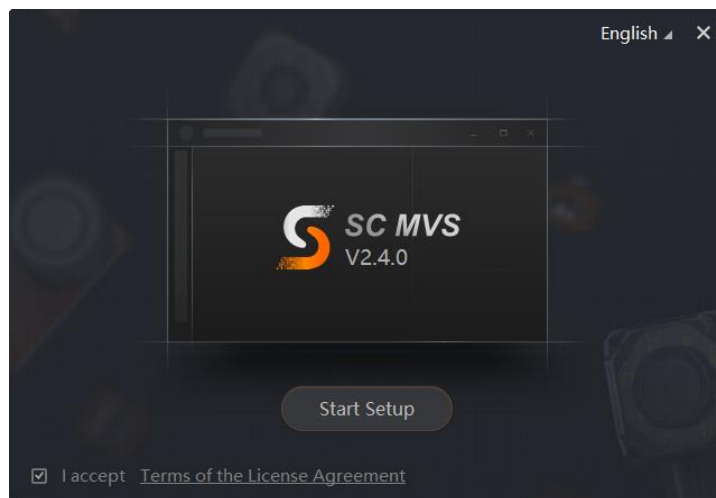

Figure 6-2 Installation Window

5. Select installation directory and click **Next**.

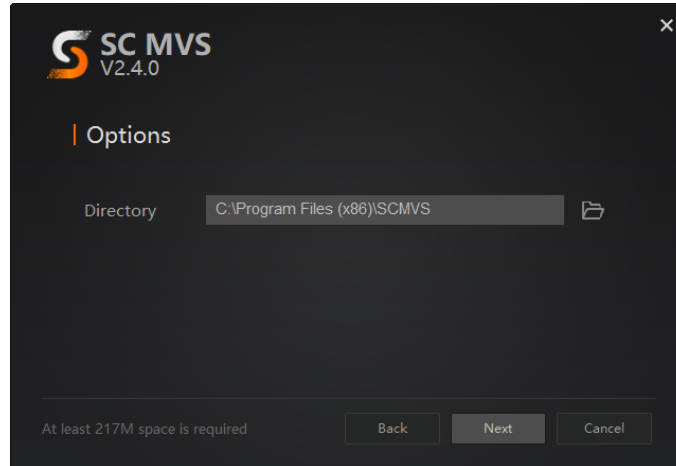



Figure 6-3 Click Next

6. Finish the installation according to the interface prompts.

6.3 Set Device Network

You can set and operate the device in the client software only when the device is in the same network segment with the PC where the client software is installed.

Steps

1. Double click the client software to run it.
2. Click  in the device list to find the device, or click  to add the device remotely.
3. Right click the device to be connected.
4. Click **Edit IP Address**.
5. Set the IP address of the device in the same network segment with the PC.

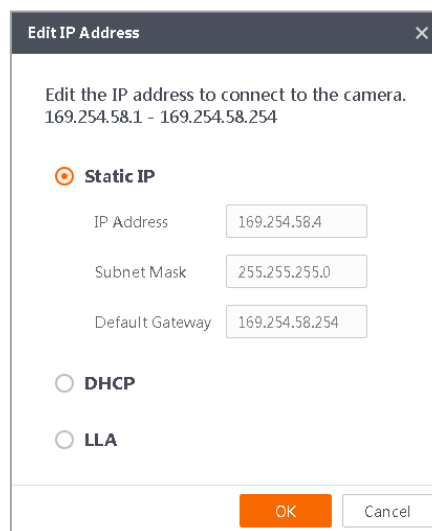

Figure 6-4 Edit IP Address

6. Click **OK**.

6.4 Login

Note

- Make sure that your device IP address is in the same network segment with the PC where you installed the client software before connecting the device to it.
 - The default login password is Abc1234, and it is highly recommended to change the password for the first time use.
 - Follow the guidance to find the password if you forget it.
 - Refer to the user manual of the SCMVS client software for detailed operation.
-

Steps

1. Click the device in the device list.
2. Enter password.
3. Click  to log in.

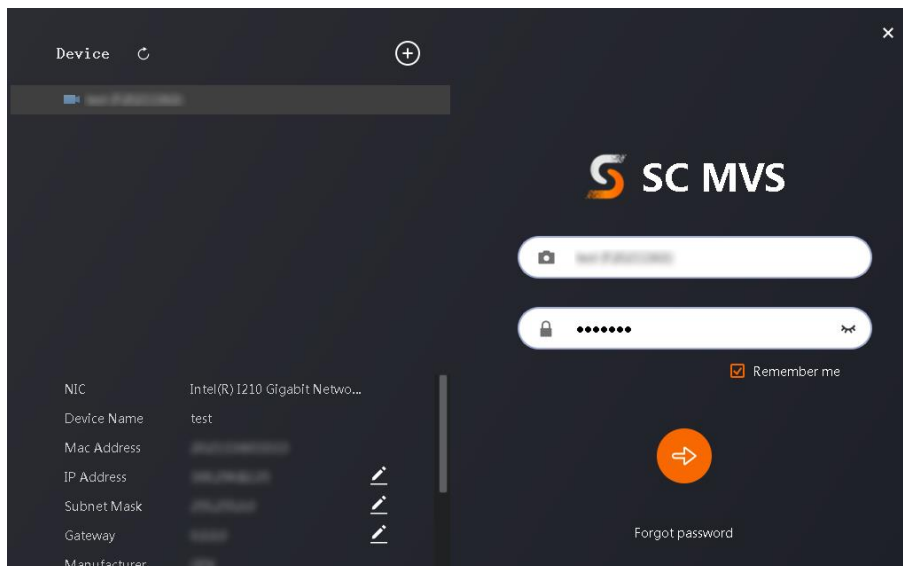

Figure 6-5 Login Window

4. (Optional) Check **Remember me** to remember the password if necessary.
-

Note

If you forget password, click **Forgot Password** in the login interface to view the device's serial No., and mail it to the technical support personnel or call them to get the corresponding resetting file. After that, import the resetting file and reset the password as the default one.

Chapter 7 Client Layout and Operation Flow

7.1 Main Window Introduction

After logging into the client software, you can see the main window as shown below.

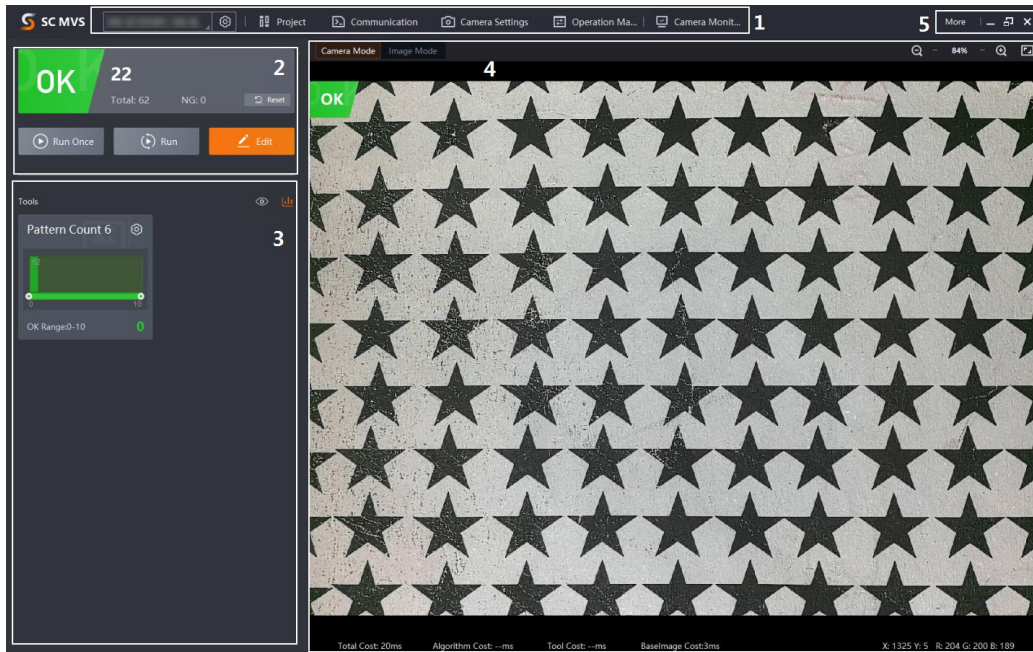



Figure 7-1 Main Window

Note

- The specific interfaces of the client software may differ by its versions.
- The client software loads and runs previous projects after logging in. If there is no project, the client software will create and run a new project.

Table 7-1 Main Window Description

No.	Name	Description
1	Menu Bar	The menu bar includes project, communication, camera settings, operation management, and camera monitoring.
2	Project Status Display Area	This area displays operation results of current projects in real time. You can run, stop or edit projects here.
3	Tool Display Area	This area displays operation results of vision tools loaded in projects in real time. You can click  to view specific operation results.

No.	Name	Description
4	Live View Window	This area displays images and results under camera mode and image mode in real time. Under image mode, you can import images into the device.
5	Other Areas	You can switch languages, view the user manual and client version information here.

7.2 Operation Flow

Note

- Refer to the user manual of the SCMVS client software for detailed parameter settings and operations.
- Click **More** on the upper right corner of the client software, and click **User Manual** to open.

You can follow the overall operation flow below to operate the device via the client software.

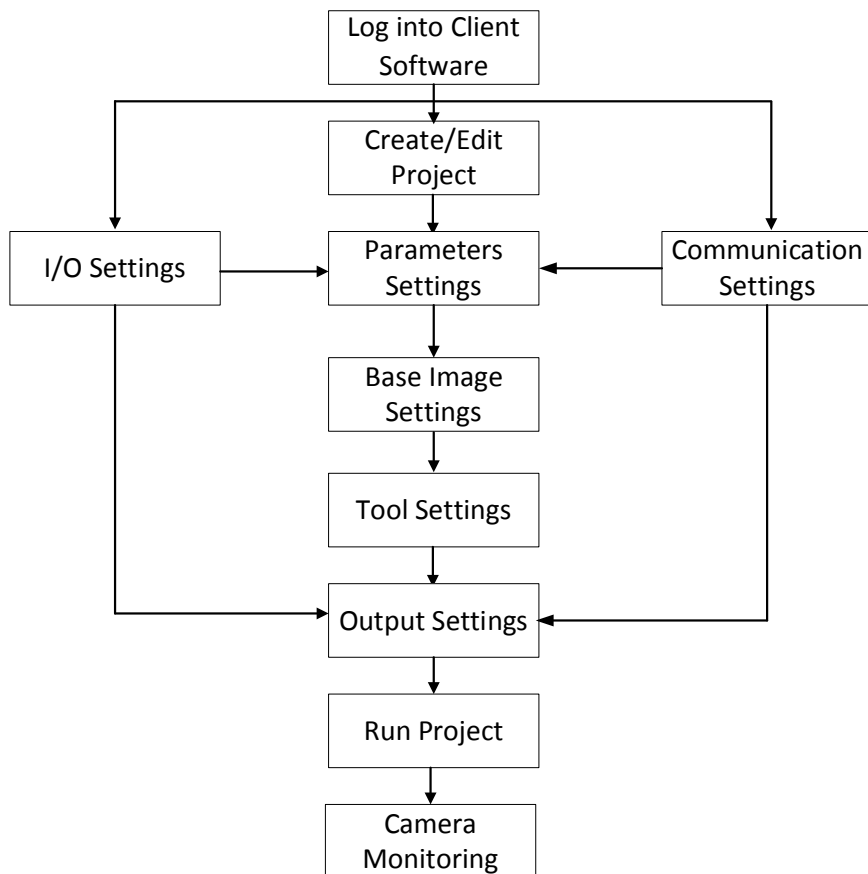

Figure 7-2 Operation Flow

Table 8-1 Input Electrical Feature

Parameter Name	Symbol	Value
Input Logic Level Low	VL	1.5 VDC
Input Logic Level High	VH	2 VDC
Input Falling Delay	TDF	81.6 μ s
Input Rising Delay	TDR	7 μ s

8.1.2 Output Signal

The device's LINE 3/4/5 are opto-isolated outputs, and their internal circuit is as follows.

Note

- The output voltage ranges from 5 VDC to 30 VDC.
- The maximum output current is 45 mA.
- Do not directly connect with inductive load (e.g. DC motor, etc.) when outputting.
- If the external voltage and resistance change, the corresponding current of output signal and output logic level low may differ.

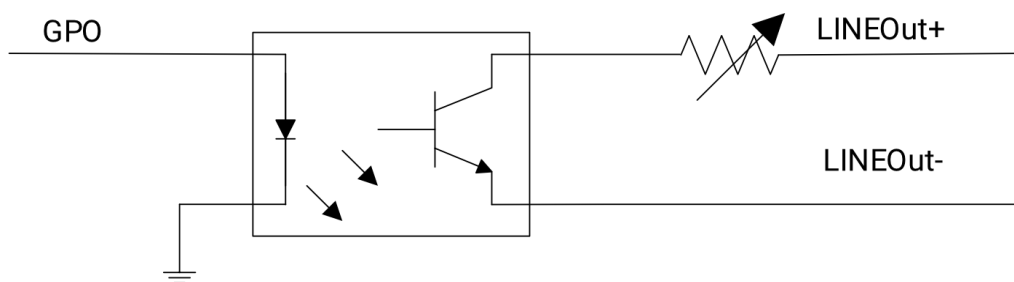

Figure 8-3 Internal Circuit of Output Signal

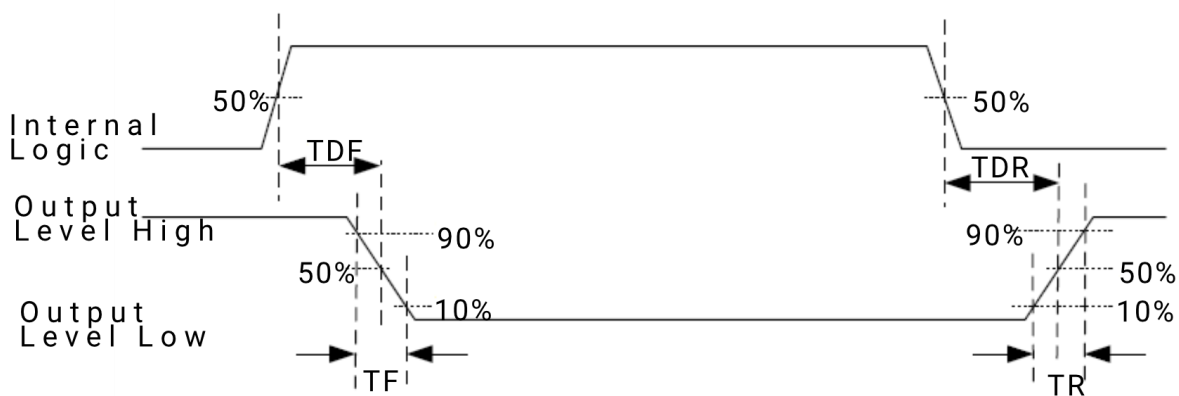

Figure 8-4 Output Logic Level

Table 8-2 Output Electrical Feature

Parameter Name	Symbol	Value
Output Logic Level Low	VL	730 mV
Output Logic Level High	VH	3.2 VDC
Output Falling Delay	TDF	6.3 μ s
Output Rising Delay	TDR	68 μ s
Output Falling Time	TF	3 μ s
Output Rising Time	TR	60 μ s

8.2 I/O Wiring

The device receives an externally input signal or output a signal to an external device through its 12-pin connector. This section introduces how to wire the I/O parts.

Note

Here we take LINE 0 as an example to introduce input signal wiring, and take LINE 3 as an example to introduce output signal wiring.

8.2.1 Input Signal Wiring

Note

Input signal wiring may differ by external device types.

PNP Device

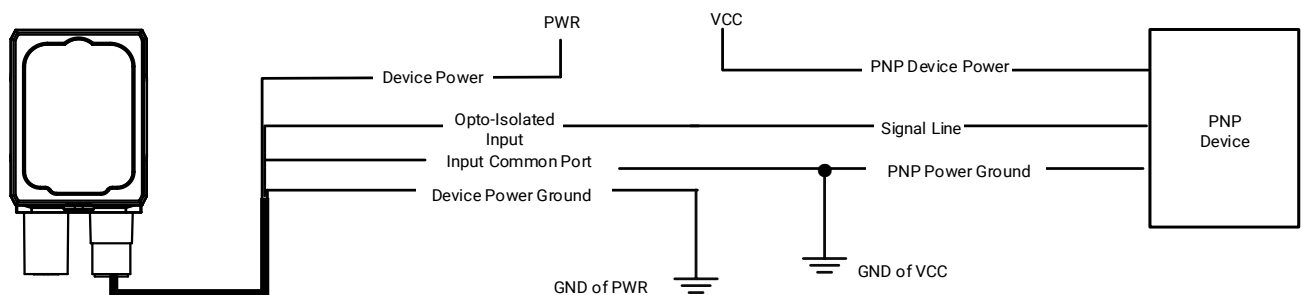

Figure 8-5 Input Signal Connecting to PNP Device

NPN Device

If the VCC of NPN device is 12 VDC or 24 VDC and pull-up resistor is not used, and its wiring is as follows.

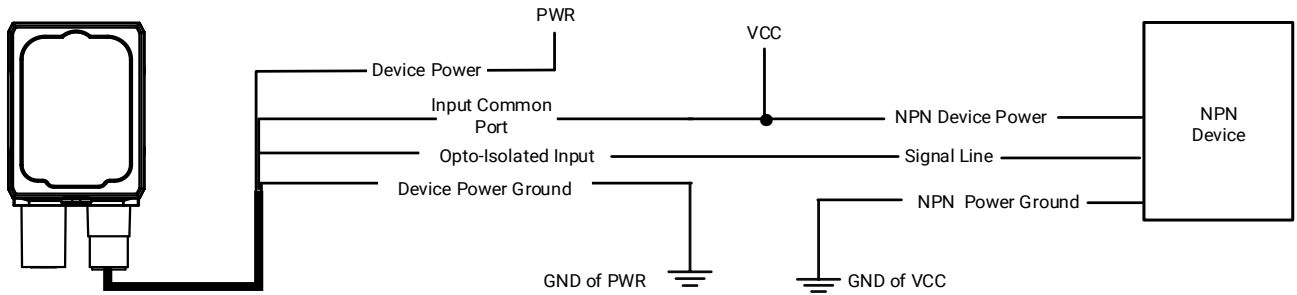

Figure 8-6 Input Signal Connecting to NPN Device without Pull-Up Resistor

If the VCC of NPN device is 12 VDC or 24 VDC and 1 K Ω pull-up resistor is used, its wiring is as follows.

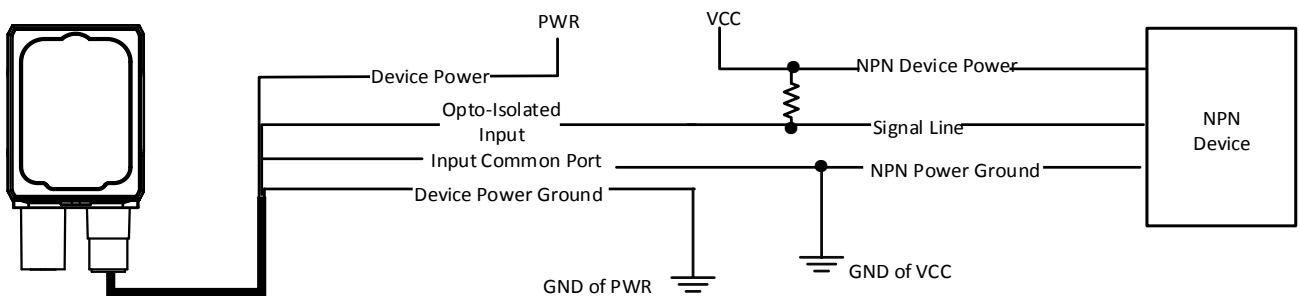

Figure 8-7 Input Signal Connecting to NPN Device with Pull-Up Resistor

8.2.2 Output Signal Wiring

Note

- Output signal wiring may differ by external device types.
- The voltage of VCC should not higher than that of PWR. Otherwise, the device's output signal may have exception.

PNP Device

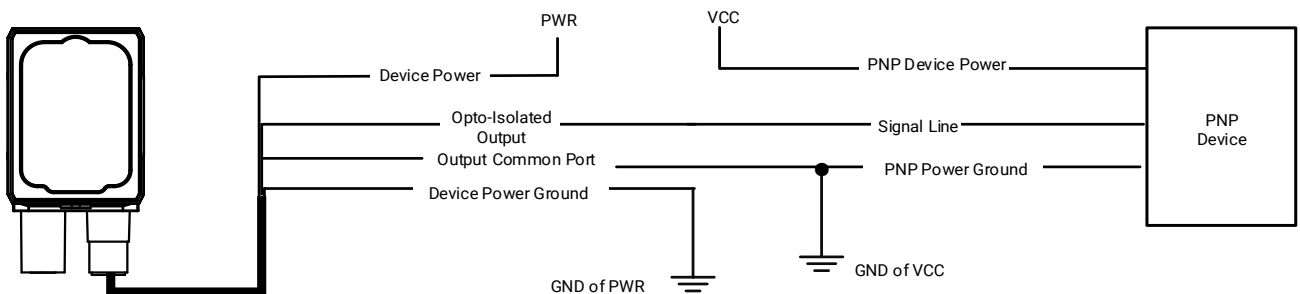

Figure 8-8 Output Signal Connecting to PNP Device

NPN Device

If the VCC of NPN device is 12 VDC or 24 VDC and pull-up resistor is not used, its wiring is as follows.

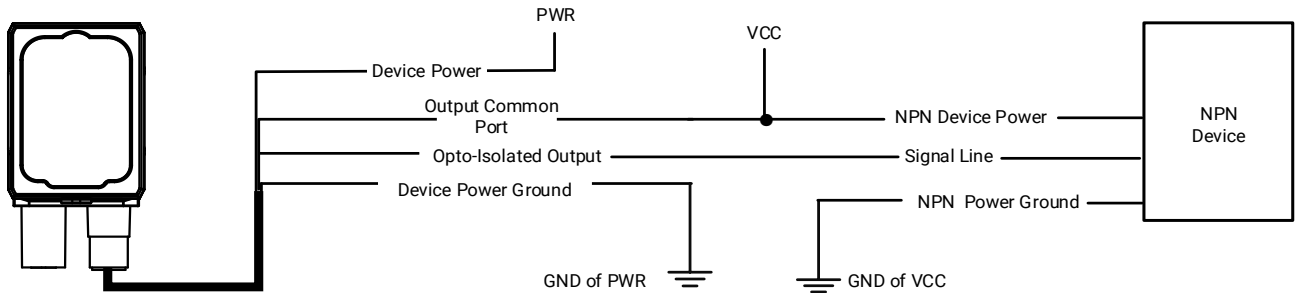

Figure 8-9 Output Signal Connecting to NPN Device without Pull-Up Resistor

If the VCC of NPN device is 12 VDC or 24 VDC and 1 K Ω pull-up resistor is used, its wiring is as follows.

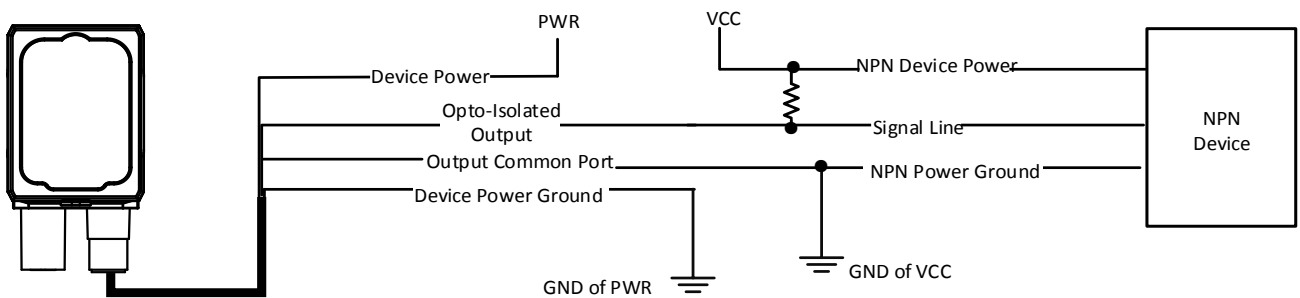

Figure 8-10 Output Signal Connecting to NPN Device with Pull-Up Resistor

8.3 RS-232 Serial Port

The device supports outputting via the RS-232 serial port.

8.3.1 RS-232 Serial Port Introduction

The 9-pin male connector and 25-pin male connector are commonly used serial ports, as shown below. You can refer to the table below for the specific pin name and function.

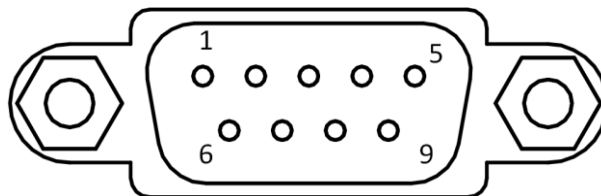

Figure 8-11 9-Pin Connector

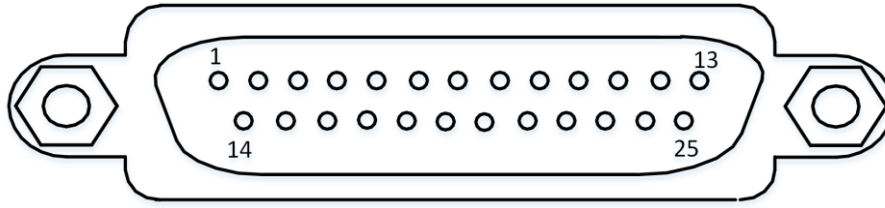

Figure 8-12 25-Pin Connector

Table 8-3 Description

Serial Port Type	Pin No.	Name	Function
9-Pin Connector	2	RX	Receive Data
	3	TX	Transmit Data
	5	GND	Signal Ground
25-Pin Connector	2	TX	Transmit Data
	3	RX	Receive Data
	7	GND	Signal Ground

8.3.2 RS-232 Serial Port Wiring

You can refer to the serial port wiring below to connect the device with an external device.

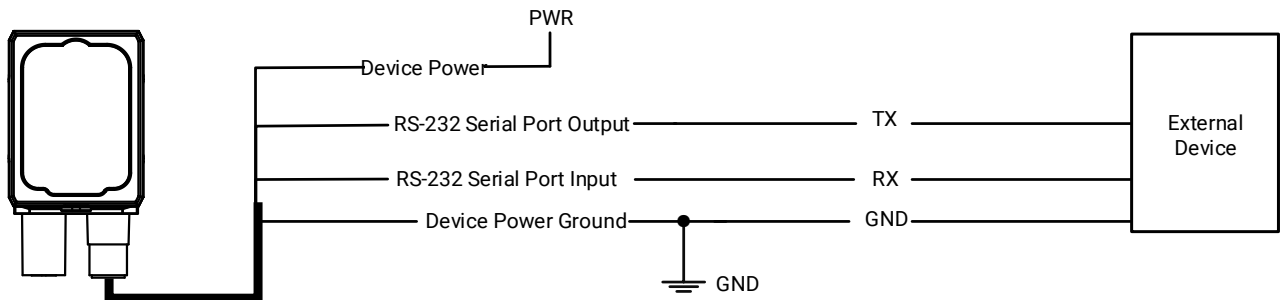

Figure 8-13 RS-232 Serial Port Wiring

Chapter 9 FAQ (Frequently Asked Question)

9.1 Why there is no device listed after I run the client software?

Problem

Run the client software, there is no listed device.

Reason

- The device is powered off.
- Network exception.

Solution

- Check the device's power connection (observe whether the indicator is unlit or not) to make sure the device is powered up normally.
- Check the network connection (the indicator is solid yellow if the network exception occurs) to make sure the device can be connected to the network normally, and make sure that the PC and the device are in the same network segment.

9.2 Why the image is very dark?

Problem

All black or too dark during live view.

Reason

- Insufficient brightness of light source.
- Too small value of exposure and gain.

Solution

- Increase the brightness of light source appropriately, or change to a brighter one.
- Increase exposure and gain appropriately.

9.3 Why the image's frame rate is very low in the live view?

Problem

Image incoherent/low frame rate/image tearing when adjusting images.

Reason

Network circuitry speed is not 100 Mbps.

Solution

Check whether the network transit speed is 100 Mbps or not.

9.4 Why there is no image in the live view?

Problem

No image in the live view.

Reason

Enabled trigger mode, but there is no trigger signal.

Solution

Sent the trigger signal to the device, or disable the trigger mode.



HIKROBOT

SHAPE OUR FUTURE INTELLIGENTLY

Hangzhou Hikrobot Technology Co.,Ltd.

E-mail: global.support@hikrobotics.com

Website: <https://en.hikrobotics.com/>

UD35076B-A