

Hangzhou Hikrobot Technology Co.,Ltd.

Wireless Handheld Code Reader

User Manual

HIKROBOT

Legal Information

©2023 Hangzhou Hikrobot Co., Ltd. All rights reserved.

About this Manual

The document includes instructions for using and managing the product. Pictures, charts, images and all other information hereinafter are for description and explanation only. The information contained in the document is subject to change, without notice, due to firmware updates or other reasons. Please find the latest version in the company website (<https://en.hikrobotics.com/>). Unless otherwise agreed, Hangzhou Hikrobot Co., Ltd. or its affiliates (hereinafter referred to as "Hikrobot") makes no warranties, express or implied. Please use the Document with the guidance and assistance of professionals trained in supporting the Product.

Acknowledgment of Intellectual Property Rights

Hikrobot owns the copyrights and/or patents related to the technology embodied in the Products described in this Document, which may include licenses obtained from third parties. Any part of the Document, including text, pictures, graphics, etc., belongs to Hikrobot. No part of this Document may be excerpted, copied, translated, or modified in whole or in part by any means without written permission.

HIKROBOT and other Hikrobot's trademarks and logos are the properties of Hikrobot in various jurisdictions. Other trademarks and logos mentioned are the properties of their respective owners.

Disclaimer

TO THE MAXIMUM EXTENT PERMITTED BY APPLICABLE LAW, THIS MANUAL AND THE PRODUCT DESCRIBED, WITH ITS HARDWARE, SOFTWARE AND FIRMWARE, ARE PROVIDED "AS IS" AND "WITH ALL FAULTS AND ERRORS". HIKROBOT MAKES NO WARRANTIES, EXPRESS OR IMPLIED, INCLUDING WITHOUT LIMITATION, MERCHANTABILITY, SATISFACTORY QUALITY, OR FITNESS FOR A PARTICULAR PURPOSE. THE USE OF THE PRODUCT BY YOU IS AT YOUR OWN RISK. IN NO EVENT WILL HIKROBOT BE LIABLE TO YOU FOR ANY SPECIAL, CONSEQUENTIAL, INCIDENTAL, OR INDIRECT DAMAGES, INCLUDING, AMONG OTHERS, DAMAGES FOR LOSS OF BUSINESS PROFITS, BUSINESS INTERRUPTION, OR LOSS OF DATA, CORRUPTION OF SYSTEMS, OR LOSS OF DOCUMENTATION, WHETHER BASED ON BREACH OF CONTRACT, TORT (INCLUDING NEGLIGENCE), PRODUCT LIABILITY, OR OTHERWISE, IN CONNECTION WITH THE USE OF THE PRODUCT, EVEN IF HIKROBOT HAS BEEN ADVISED OF THE POSSIBILITY OF SUCH DAMAGES OR LOSS.

YOU ACKNOWLEDGE THAT THE NATURE OF INTERNET PROVIDES FOR INHERENT SECURITY RISKS, AND HIKROBOT SHALL NOT TAKE ANY RESPONSIBILITIES FOR ABNORMAL OPERATION, PRIVACY LEAKAGE OR OTHER DAMAGES RESULTING FROM CYBER-ATTACK, HACKER ATTACK, VIRUS INFECTION, OR OTHER INTERNET SECURITY RISKS; HOWEVER, HIKROBOT WILL PROVIDE TIMELY TECHNICAL SUPPORT IF REQUIRED.

YOU AGREE TO USE THIS PRODUCT IN COMPLIANCE WITH ALL APPLICABLE LAWS, AND

YOU ARE SOLELY RESPONSIBLE FOR ENSURING THAT YOUR USE CONFORMS TO THE APPLICABLE LAW. ESPECIALLY, YOU ARE RESPONSIBLE, FOR USING THIS PRODUCT IN A MANNER THAT DOES NOT INFRINGE ON THE RIGHTS OF THIRD PARTIES, INCLUDING WITHOUT LIMITATION, RIGHTS OF PUBLICITY, INTELLECTUAL PROPERTY RIGHTS, OR DATA PROTECTION AND OTHER PRIVACY RIGHTS. YOU SHALL NOT USE THIS PRODUCT FOR ANY PROHIBITED END-USES, INCLUDING THE DEVELOPMENT OR PRODUCTION OF WEAPONS OF MASS DESTRUCTION, THE DEVELOPMENT OR PRODUCTION OF CHEMICAL OR BIOLOGICAL WEAPONS, ANY ACTIVITIES IN THE CONTEXT RELATED TO ANY NUCLEAR EXPLOSIVE OR UNSAFE NUCLEAR FUEL-CYCLE, OR IN SUPPORT OF HUMAN RIGHTS ABUSES.

THE PERFORMANCE DATA IN THIS PUBLICATION IS BASED ON HIKROBOT'S INTERNAL RESEARCH/EVALUATION. ACTUAL DATA MAY VARY DEPENDING ON SPECIFIC CONFIGURATIONS AND OPERATING CONDITIONS AND HIKROBOT SHALL NOT BEAR THE CONSEQUENCES ARISING THEREFROM.

IN THE EVENT OF ANY CONFLICTS BETWEEN THIS MANUAL AND THE APPLICABLE LAW, THE LATTER PREVAILS.

Regulatory Information

Note

These clauses apply only to the products bearing the corresponding mark or information.

FCC Information

Please take attention that changes or modification not expressly approved by the party responsible for compliance could void the user's authority to operate the equipment.

FCC Compliance

This equipment has been tested and found to comply with the limits for a Class A digital device, pursuant to part 15 of the FCC Rules. These limits are designed to provide reasonable protection against harmful interference when the equipment is operated in a commercial environment. This equipment generates, uses, and can radiate radio frequency energy and, if not installed and used in accordance with the instruction manual, may cause harmful interference to radio communications. Operation of this equipment in a residential area is likely to cause harmful interference in which case the user will be required to correct the interference at his own expense.

FCC Conditions

This device complies with part 15 of the FCC Rules. Operation is subject to the following two conditions:

- This device may not cause harmful interference.
- This device must accept any interference received, including interference that may cause undesired operation.

EU Conformity Statement



This product and - if applicable - the supplied accessories too are marked with "CE" and comply therefore with the applicable harmonized European standards listed under the Directive 2014/30/EU(EMCD), Directive 2001/95/EC(GPSD) and Directive 2011/65/EU(RoHS).



2012/19/EU (WEEE directive): Products marked with this symbol cannot be disposed of as unsorted municipal waste in the European Union. For proper recycling, return this product to your local supplier upon the purchase of equivalent new equipment, or dispose of it at designated collection points. For more information see: <http://www.recyclethis.info>



2006/66/EC (battery directive): This product contains a battery that cannot be disposed of as unsorted municipal waste in the European Union. See the product documentation for specific battery information. The battery is marked with this symbol, which may include lettering to indicate cadmium (Cd), lead (Pb), or mercury (Hg). For proper recycling, return the battery to your supplier or to a designated collection point. For more information see: <http://www.recyclethis.info>

Warning: This is a class A product. In a domestic environment this product may cause radio interference in which case the user may be required to take adequate measures.

KC Certification

Class A: The device is advised to note that as a seller or a business user (Class A) Devices and intended for use outside the Home area.

A급 기기: 이 기기는 업무용(A급) 전자파적합기기로서 판매자 또는 사용자는 이 점을 주의하시기바라며, 가정 외의 지역에서 사용하는 것을 목적으로 합니다.

Symbol Conventions

The symbols that may be found in this document are defined as follows.

Symbol	Description
Danger	Indicates a hazard with a high level of risk, which if not avoided, will result in death or serious injury.
Caution	Indicates a potentially hazardous situation which, if not avoided, could result in equipment damage, data loss, performance degradation, or unexpected results.
Note	Provides additional information to emphasize or supplement important points of the main text.

Available Model

This manual is applicable to the wireless handheld code reader.

Contact Information

Hangzhou Hikrobot Co., Ltd.

E-mail: global.support@hikrobotics.com

Website: <https://en.hikrobotics.com/>

Contents

Chapter 1 Safety Instruction	1
1.1 Safety Claim	1
1.2 Safety Instruction	1
1.3 Electromagnetic Interference Prevention.....	2
Chapter 2 Overview.....	4
2.1 Introduction.....	4
2.2 Key Features.....	4
Chapter 3 Appearance	5
3.1 Device Appearance.....	5
3.2 Smart Base Appearance	9
Chapter 4 Device Connection and Basic Operation	15
4.1 Accessories	15
4.2 Device Connection.....	16
4.2.1 Type II Device.....	16
4.2.2 Type III Device	17
4.2.3 Type IV Device	20
4.3 Install Smart Base	20
4.3.1 Type II Device.....	21
4.3.2 Type IV Device	21
4.4 Charge Device	21
4.4.1 Type II and Type III Devices.....	22
4.4.2 Type IV Device	24
4.5 Basic Operation	24
Chapter 5 Client Software Installation and Operation	26
5.1 Install Client Software	26
5.2 Set PC Environment	27
5.2.1 Turn off Firewall for Network Type Smart Base	27
5.2.2 Set PC Network for Network Type Smart Base	27
5.2.3 Check USB Drive for USB Type Smart Base	28

5.3 Set Device Network	29
5.4 Connect Device to Client Software	29
Chapter 6 Client Software Layout.....	30
Chapter 7 Device Mode Settings	32
Chapter 8 Setting Codes	33
8.1 Introduction	33
8.2 Enable/Disable Setting Codes	33
8.3 Set Setting Codes of Code Type	34
8.4 Set Setting Codes of Code Reading Mode	37
8.5 Set Setting Codes of Code Reading Quantity	37
8.6 Set Setting Codes of Data Processing	39
8.7 Set Setting Codes of Aiming System	42
8.8 Set Setting Codes of Light Source.....	43
8.9 Set Setting Codes of Buzzer	44
8.10 Set Setting Codes of Vibration.....	45
8.11 Set Setting Codes of USB Communication.....	46
8.12 Set Setting Codes of Switching Bluetooth Mode.....	48
8.13 Set Setting Codes of Code Color	48
8.14 Set Setting Codes of Trigger	49
8.15 Set Setting Codes of Device Information.....	50
8.16 Set Setting Codes of Management	51
Chapter 9 Device Settings.....	52
9.1 Feature Tree Introduction	52
9.2 Code Reading Mode Settings	53
9.3 Device Control Settings.....	54
9.3.1 Device Parameters.....	54
9.3.2 Smart Base Parameters	55
9.4 Prompt Settings.....	56
9.4.1 Set Buzzer	56
9.4.2 Set Vibrator	56
9.4.3 Set Button of Smart Base	57
9.5 Image Quality Settings	57

9.5.1 Set Image	58
9.5.2 Set Exposure	59
9.5.3 Set Gain	59
9.5.4 Set Light Source	60
9.5.5 Set Mirror X	61
9.5.6 Set Test Pattern	62
9.6 Code Algorithm Settings	62
9.6.1 Add Code	62
9.6.2 Set Algorithm Parameter	63
9.7 Signal Input Settings	64
9.7.1 Set and Execute Hardware Tigger	64
9.7.2 Set and Execute Response Tigger	65
9.7.3 Set and Execute Self Tigger	65
9.8 Code Reading Result Settings	66
9.8.1 Set Filter Rule	66
9.8.2 Set Result Format	67
9.9 Communication Settings	72
9.9.1 Smart SDK	72
9.9.2 USB	72
9.9.3 TCP Client	73
9.9.4 Serial	74
9.9.5 FTP	74
9.9.6 TCP Server	75
9.9.7 UDP	75
9.9.8 ModBus	75
9.9.9 Bluetooth	77
9.9.10 Profinet	77
9.9.11 Ethernet/IP	78
9.9.12 2.4G	78
9.10 User Set Customization	78
Chapter 10 Device Operation	80
10.1 Live View	80

10.2 Enable Acquisition	80
10.3 Add Cross Line.....	81
10.4 Start Recording.....	81
10.5 Split Window	82
10.6 View Reports	82
10.7 View Log	83
10.8 Set Time.....	83
10.9 Enable Device Auto Work.....	84
Chapter 11 Device Maintenance.....	85
11.1 Update Firmware	85
11.2 Recover to Factory Settings	85
11.3 Reboot Device.....	86
Chapter 12 FAQ (Frequently Asked Question)	87
12.1 Why there is no buzzer sound and the indicator is unlit after the device is connected?.....	87
12.2 Why the device does not read codes after powering on and getting triggered?	87
12.3 Why the device does not read codes after connecting to client software and getting triggered?.....	87
12.4 Why there is no buzzer sound after the device reads codes successfully?	88
12.5 Why configuring setting codes failed though there is buzzer sound?.....	88
12.6 Why only a few codes read successfully on the batch code reading mode?	88
Appendix A ASCII Table	89

Chapter 1 Safety Instruction

The safety instructions are intended to ensure that the user can use the device correctly to avoid danger or property loss. Read and follow these safety instructions before installing, operating and maintaining the device.

1.1 Safety Claim

- To ensure personal and device safety, when installing, operating, and maintaining the device, follow the signs on the device and all safety instructions described in the manual.
- The note, caution and danger items in the manual do not represent all the safety instructions that should be observed, but only serve as a supplement to all the safety instructions.
- The device should be used in an environment that meets the design specifications, otherwise it may cause malfunctions, and malfunctions or component damage caused by non-compliance with relevant regulations are not within the scope of the device's quality assurance.
- Our company will not bear any legal responsibility for personal safety accidents and property losses caused by abnormal operation of the device.

1.2 Safety Instruction

Caution:

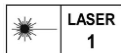
- Some models of the device's laser radiation conform to IEC 60825-1:2014 and EN 60825-1:2014+A11:2021. 
- In the use of the device, you must be in strict compliance with the electrical safety regulations of the nation and region.
- Install the device in accordance with the installation method mentioned in this manual, and makes sure that the device is firmly fixed.
- It is forbidden to install the indoor device in an environment where it may be exposed to water or other liquids. If the device is damp, it may cause fire and electric shock hazard.
- If the device emits smoke, odor or noise, please turn off the power and unplug the power cord immediately, and contact the dealer or service center in time.
- Use the power adapter provided by the official manufacturer. The power adapter must meet the Limited Power Source (LPS) requirements. For specific requirements, please refer to the device's technical specifications.
- Do not cover the device's plug or outlet for disconnecting power supply.
- It is strictly forbidden to install, wire or maintain the device when it is powered on, otherwise there is a danger of electric shock.
- Replacing a battery with the wrong model (e.g. some types of lithium batteries) may result

in the safety guard being voided.

- Caution: Risk of explosion if battery is replaced by an incorrect type. Dispose of used batteries according to the instructions.
- Protective measures like wearing safety goggles are required when installing, maintaining and debugging the device.
- Avoid aiming the lens at strong light (such as lighting, sunlight, or laser beams, etc.), otherwise the image sensor will be damaged.
- If it is necessary to clean the device, use a damp paper towel or a soft clean cloth to moisten a little pure water, gently wipe off the dust, and do not use alcohol-based corrosive solutions. Make sure to power off the device and unplug the power socket when cleaning.
- If the device does not work properly, please contact your dealer or the nearest service center. Never attempt to disassemble the device yourself (we shall not assume any responsibility for problems caused by unauthorized repair or maintenance).
- Please dispose of the device in strict accordance with the relevant national or regional regulations and standards to avoid environmental pollution and property damage.

Note:

- Check whether the device's package is in good condition, whether there is damage, intrusion, moisture, deformation, etc. before unpacking.
- Check the surface of the device and accessories for damage, rust, bumps, etc. when unpacking.
- Check whether the quantity and information of the device and accessories are complete after unpacking.
- Store and transport the device according to the storage and transport conditions of the device, and the storage temperature and humidity should meet the requirements.
- It is strictly prohibited to transport the device in combination with items that may affect or damage the device.
- Please read the manual and safety instructions carefully before installing the device.
- The device should not be placed with exposed flame sources, such as lighted candles.
- Quality requirements for installation and maintenance personnel:
 - Qualification certificate or working experience in weak current system installation and maintenance, and relevant working experience and qualifications. Besides, the personnel must possess the following knowledge and operation skills.
 - The basic knowledge and operation skills of low voltage wiring and low voltage electronic circuit connection.
 - The ability to comprehend the contents of this manual.

1.3 Electromagnetic Interference Prevention

- Make sure that the shielding layer of cables is intact and 360° connected to the metal connector when using shielded cables.
- Do not route the device together with other equipment (especially servo motors, high-power devices, etc.), and control the distance between cables to more than 10 cm. Make

sure to shield the cables if unavoidable.

- The control cable of the device and the power cable of the industrial light source must be wired separately to avoid bundled wiring.
- The power cable, data cable, signal cable, etc. of the device must be wired separately. Make sure to ground them if the wiring groove is used to separate the wiring and the wiring groove is metal.
- During the wiring process, evaluate the wiring space reasonably, and do not pull the cables hard, so as not to damage the electrical performance of the cables.
- If the device is powered on and off frequently, it is necessary to strengthen the voltage isolation, and consider adding a DC/DC isolation power supply module between the device and the adapter.
- Use the power adapter to supply power to the device separately. If centralized power supply is necessary, make sure to use a DC filter to filter the power supply of the device separately before use.
- The unused cables of the device must be insulated.
- When installing the device, if you cannot ensure that the device itself and all equipment connected to the device are well grounded, you should isolate the device with an insulating bracket.
- To avoid the accumulation of static electricity, ensure that other equipment (such as machines, internal components, etc.) and metal brackets on site are properly grounded.
- Make sure that the connector metal barrier of the device is well connected to the PC and other chassis, and if necessary, copper foil should be used to enhance the grounding effect.
- During the installation and use of the device, high voltage leakage must be avoided.
- Use a figure-eight bundle method if the device cable is too long.
- When connecting the device and metal accessories, they must be connected firmly to maintain good conductivity.
- Use a shielded network cable to connect to the device. If you use a self-made network cable, make sure that the shielding shell at the aviation head is well connected to the aluminum foil or metal braid of the shielding cable.

Chapter 2 Overview

2.1 Introduction

The wireless handheld code reader adopts code reading algorithm to provide good decoding capability for DPM. It can read different types of one-dimensional and two-dimensional codes, and output codes rapidly. It adopts illumination system to provide direct lighting and diffused reflection lighting.

The device uses sensor and optical elements to obtain images of the measured objects, and realizes code analysis via its built-in deep learning code algorithm. With adaptive smart bases, the device can realize charging and data communication. The device supports parameter debugging via the client software.

2.2 Key Features

- Adopts code reading algorithm to provide good decoding capability.
- Provides good robustness to read codes with spots, defects and low contrast ratio.
- Adopts Bluetooth 5.0 wireless technology to provide convenient and efficient operations.
- With smart bases, parameter configuration and device management via IDMVS client software are supported.
- Adopts 3150 mAh battery to provide long battery life.
- Adopts illumination system to provide direct lighting and diffused reflection lighting.

Note

- Key features may differ by device models.
 - Refer to the specification of the device for detailed parameters.
-

Chapter 3 Appearance

3.1 Device Appearance

 **Note**

The device appearance here is for reference only. Refer to the device's specification for detailed dimension information.

Currently, the wireless handheld code reader has three types of appearance (type II, type III and type IV), as shown below.

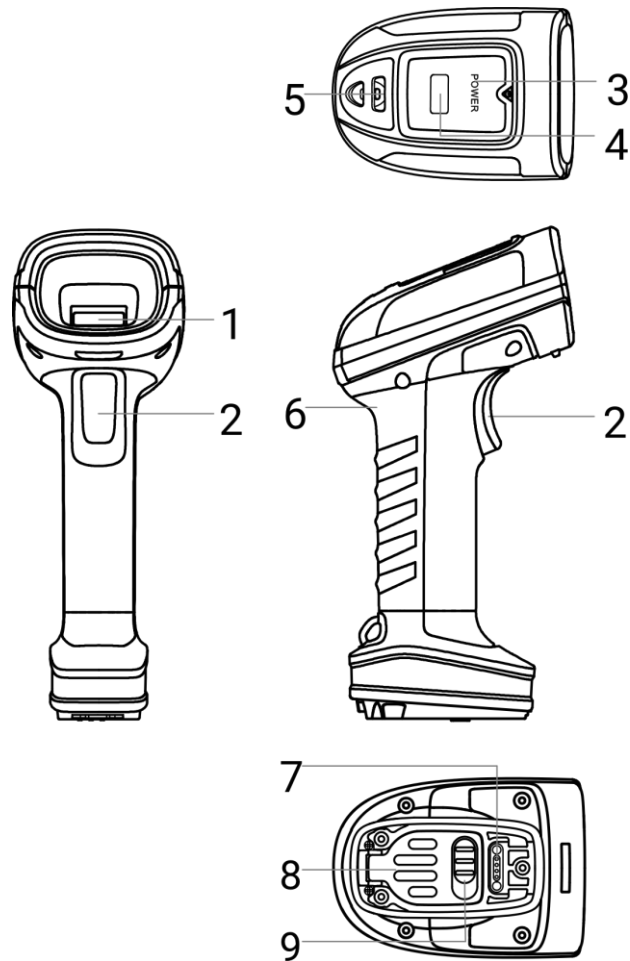

Figure 3-1 Appearance (Type II)

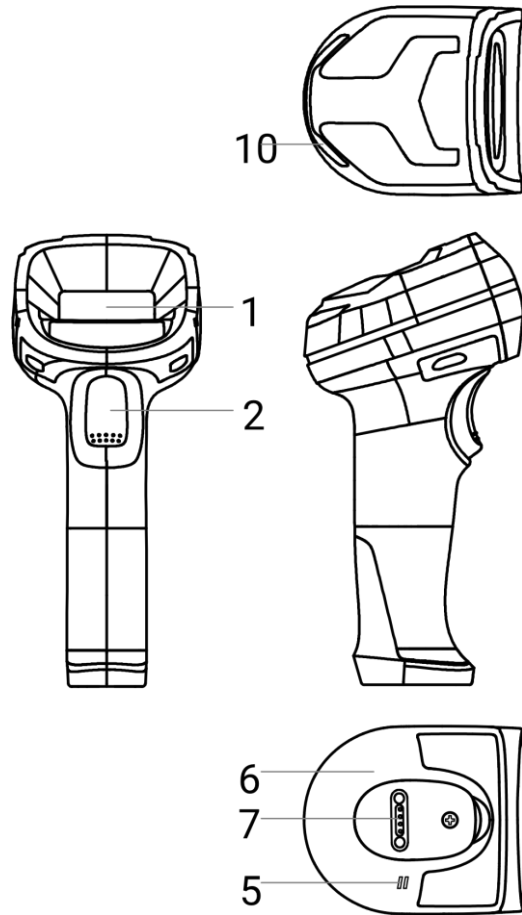

Figure 3-2 Appearance (Type III)

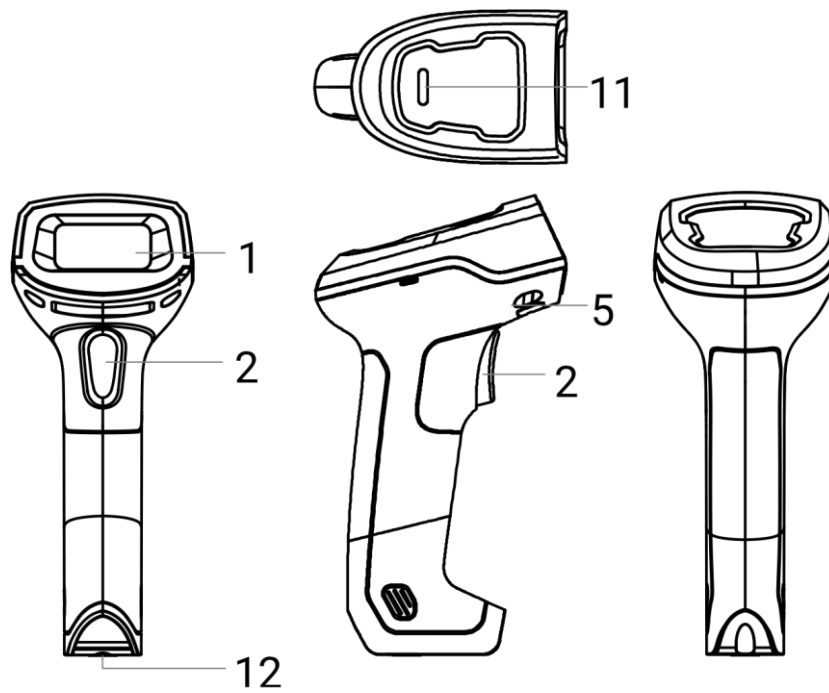





Figure 3-3 Appearance (Type IV)

Table 3-1 Component Description

No.	Name	Description
1	Reading Window	<p>It is used to acquire images, and consists of sensor, lens, supplement light, aiming system, etc.</p> <p> Note The components of reading window may differ by device models.</p>
2	Tigger Switch	<p>Press the trigger switch to trigger the device once when the device is in an external trigger mode.</p> <p> Note After disconnecting the Bluetooth connection between the device and smart base, put the device on the smart base, press and hold the trigger switch for 10 sec, and release the trigger switch when you hear a beeping sound. When you hear a beeping sound again, press and hold the trigger switch for 3 sec to restore the device to factory settings.</p>
3	Power Indicator (Type II Device)	<p>It indicates the status of power supply, Bluetooth connection, battery level, and firmware for the type II device.</p> <ul style="list-style-type: none"> ● The indictor is turned off at the moment of the device is powered on, it is solid red during the device is powered on, it is solid green after the device is powered on and Bluetooth is not connected, it is flashing green during Bluetooth connection, and it is solid orange after the Bluetooth is connected. ● The indicator is flashing red when the device's battery level is lower than 20% and is not charged. ● The indicator is flashing orange when the device is updating firmware. If updating fails, the indicator will be solid red lasting 3 sec until restating the device. If updating successes, the indicator will be solid green lasting 3 sec until restating the device.
4	STS Indicator (Type II Device)	<p>It indicates the type II device's status, code reading status, and calling status.</p> <ul style="list-style-type: none"> ● The indicator is solid red when the device starts up and unlit after being powered on. The indicator is in green color (lasting 0.5 sec) when the device recognizes codes, and is in red color (lasting 0.5 sec) when the device does not recognize codes. ● The indicator flashes for three times in red color when the smart base calls the device.
5	Buzzer	<p>It indicates the device's operation status via sound.</p> <ul style="list-style-type: none"> ● The buzzer beeps three times when the device starts up. ● The buzzer beeps once when the device scan Bluetooth pairing

Wireless Handheld Code Reader User Manual

No.	Name	Description
		<p>code, beeps once when the device accesses to its smart base or receiver successfully, and beeps twice if accessing fails. Besides, the buzzer beeps once when the Bluetooth is disconnected.</p> <ul style="list-style-type: none"> ● The buzzer beeps once when the device reads codes successfully. ● The buzzer beeps twice when the device reads setting codes successfully. ● The buzzer beeps once when the device is put into its smart base. ● The buzzer beeps once with duration of 2 sec when the device enters low consumption mode. ● The buzzer beeps once (type II device lasting 5 sec, type III device lasting 3 sec) when the device fails to update firmware. ● The buzzer beeps three times in circle when the smart base calls the device.
6	Vibrator	<p>It indicates the device's operation status via vibration.</p> <ul style="list-style-type: none"> ● The device vibrates for 0.3 sec when it finishes starting up. ● The device vibrates once each after Bluetooth is connected or disconnected. ● The device vibrates for 0.3 sec when it recognize codes. ● The device vibrates twice (duration 300 ms, interval 300 ms) when it recognizes setting codes. ● The device vibrates once (duration 2 sec) when it enters low consumption mode.
7	Magnet	It is used to fix the device to the smart base.
8	Battery Holder	It is used to store and charge batteries.
9	Locker	It is used to lock batter cover.
10	Indicator (Type III Device)	<p>It indicates the type III device's operation status.</p> <ul style="list-style-type: none"> ● The indictor is solid red during the device is powered on, is solid yellow after being powered on and Bluetooth is not connected, is flashing green during Bluetooth connection, and is unlit after Bluetooth is connected. ● The indicator is in green color when the device recognizes codes, and is in red color when it does not recognize codes. ● The indicator is in green color when the device recognizes setting codes. ● The indicator is flashing green when the device transmits data. ● The indicator is flashing red when the device's battery level is lower than 20% and is not charged. ● The indicator is flashing yellow when the device is updating its

No.	Name	Description
		firmware, is solid red lasting 3 sec until restating the device when updating fails, and is solid green lasting 3 sec until restating the device when updating succeeds.
11	Indicator (Type IV Device)	<p>It indicates the type IV device's operation status.</p> <ul style="list-style-type: none"> ● The indictor is solid red during the device is powered on, is solid orange after being powered on and USB/2.4G is not connected, and is unlit after USB/2.4G is connected. ● The indicator is in green color when the device recognizes codes, and is in red color when it does not recognize codes. ● The indicator is flashing orange when the device is updating its firmware, is solid green lasting 3 sec until restating the device when updating succeeds, and is solid red lasting 3 sec until restating the device when updating fails. ● The indicator is flashing red when the device's battery level is lower than 20% and is not charged. ● During charging, the indicator is flashing red if the device's battery level is between 0% and 40%, is flashing orange if the device's battery level is between 40% and 80%, and it is flashing green if the device's battery level is between 80% and 100%.
12	Type-B Connector	<p>It is used to connect cables to provide power supply for the device and transmit data.</p> <p> Note Only the type IV device has this connector.</p>

3.2 Smart Base Appearance

Note

The appearance of the smart base here is for reference only, and the appearance may differ by its device models.

You can use the smart base to fix the device, charge it, realize data communication or connect the device to the client software.

Smart Base of Type II Device

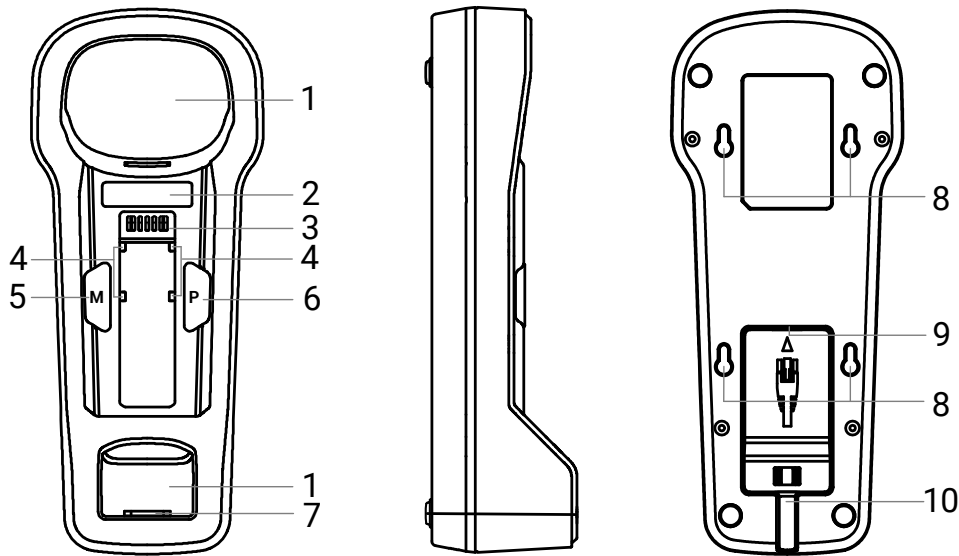

Figure 3-4 Smart Base of Type II Device

Table 3-2 Component Description

No.	Name	Description
1	Device Placement Slot	It is used to place the device.
2	Bluetooth Pairing Code	The device can be connected to the smart base via scanning the Bluetooth pairing code. After connection, you can configure the device's parameters via the client software.
3	Battery Holder	It is used to store batteries.
4	Fixing Clip	It is used to fix the battery to the battery holder.
5	Link Indicator/M Button	It is the status indicator of the smart base, and is also used to disconnect the device and the smart base by pressing it. <ul style="list-style-type: none"> ● Status indicator: The indicator is solid green when network/USB connection is normal, it is unlit when no network/USB connection, and it is flashing green when the device is transmitting data. ● M button: Press it for 3 sec to disconnect the connection between the device and the smart base. The smart base is in standby status.
6	Power Indicator/P Button	It is the power indicator of the smart base, and is also used to find the device. <ul style="list-style-type: none"> ● Power indicator:

Wireless Handheld Code Reader User Manual

No.	Name	Description
		<ul style="list-style-type: none">○ The indicator is solid red when the smart base is powered on, and after starting, the indicator is solid green when the Bluetooth is not connected, and the indicator is solid orange after the Bluetooth is connected.○ The indicator is flashing red if the battery level is lower than 40% during charging, is flashing orange if the battery level is between 40% and 80%, and is flashing green if the battery level is between 80% and 100%. The indicator is solid green when the battery level reaches 100% (Bluetooth is not connected) or is solid orange (Bluetooth is connected).○ The indicator is flashing orange (duration 200 ms, interval 1000 ms) when the device and smart base are updating firmware. If the updating fails, the indicator is solid red lasting 3 sec and then the device is restarted. If the updating is successfully, the indicator is solid green lasting 3 sec and then the device is restarted.● P button: It is used to find the device connected to the smart base.<ul style="list-style-type: none">○ Press it for 3 sec, and the smart base sends Find Me command to the device. After receiving the commands, the device will have indicator and buzzer prompts.○ Press it for 3 sec again, and the smart base stops sending Find Me command.
7	Magnet	It is used to charge the device and fix it to the smart base.
8	Holes	It is used to install the smart base.
9	Cable Connection Port	It is used to connect different cables.
10	Cable Slot	It is used to place the cable.

Smart Base of Type III Device

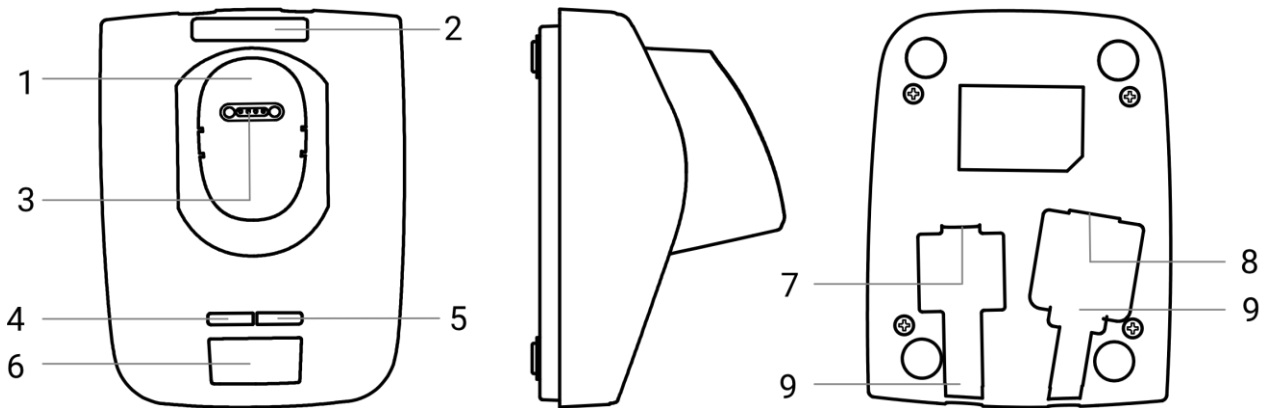

Figure 3-5 Smart Base of Type III Device

Table 3-3 Component Description

No.	Name	Description
1	Device Placement Slot	It is used to place the device.
2	Bluetooth Pairing Code	The device can be connected to the smart base via scanning the Bluetooth pairing code. After connection, you can configure the device's parameters via the client software.
3	Magnet	It is used to charge the device and fix it to the smart base.
4	STS Indicator	It is the network status indicator of the smart base. The indicator is solid green when network/USB connection is normal, is unlit when no network/USB connection, and it is flashing green when the device is transmitting data.
5	Link Indicator	It is the power indicator of the smart base. <ul style="list-style-type: none"> • The indicator is turned off at the moment of the smart base is powered on, it is solid red during it is powered on, and after starting, the indicator is solid green when the Bluetooth is not connected. • The indicator is solid yellow after the Bluetooth is connected. • During charging, the indicator is flashing red if the battery level is lower than 20%, is flashing orange if the battery level is between 20% and 80%, and is flashing green if the battery level is between 80% and 100%. The indicator is solid green when the battery level reaches 100% (Bluetooth is not connected) or is solid orange (Bluetooth is connected).

No.	Name	Description
		<ul style="list-style-type: none"> The indicator is flashing orange (duration 200 ms, interval 1000 ms) when the device and smart base are updating firmware. If the updating fails, the indicator is solid red lasting 3 sec and then the device is restarted. If the updating is successfully, the indicator is solid green lasting 3 sec and then the device is restarted.
6	Button	<p>It is used to find the device connected to the smart base, and disconnect the Bluetooth connection.</p> <ul style="list-style-type: none"> Shortly press it for less than 3 sec, and the smart base sends Find Me command to the connected device. After receiving the commands, the device will have indicator and buzzer prompts. Shortly press it for less than 3 sec again, and the smart base disconnects connection with the device, and enters standby status. Press it for more than 3 sec, disconnect the connected device from the smart base via Bluetooth.
7	Power Interface	It is used to connect the power adapter.
8	Data Interface	It is used to connect different cables.
9	Cable Slot	It is used to place the cable.

Smart Base of Type IV Device

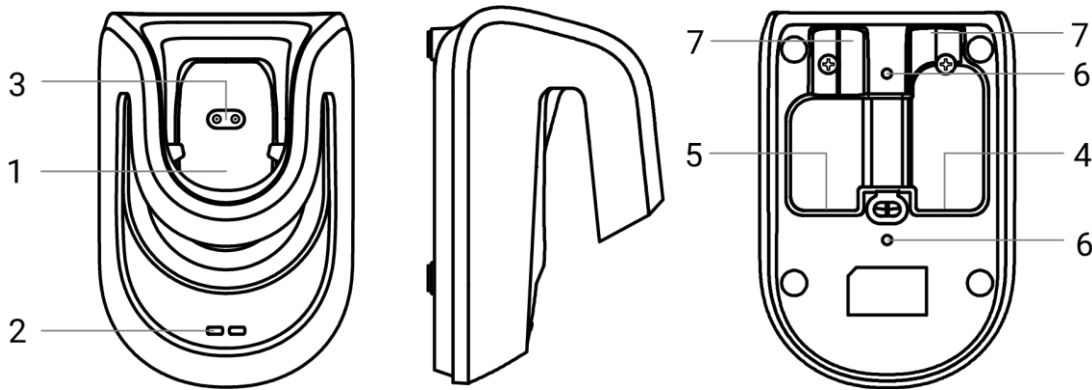

Figure 3-6 Smart Base of Type IV Device

Table 3-4 Component Description

No.	Name	Description
1	Device Placement Slot	It is used to place the device.
2	Indicator	It is the power indicator of the smart base.

Wireless Handheld Code Reader User Manual





No.	Name	Description
3	Magnet	It is used to charge the device and fix it to the smart base.
4	Type-B Connector	It is applicable to external devices with type-B connector.
5	USB Interface	It is applicable to external devices with USB interface.
6	Installation Holes	It is used to install the smart base with M3 screws.
7	Cable Slot	It is used to place the cable.

Chapter 4 Device Connection and Basic Operation

4.1 Accessories

You need to prepare following accessories before device connection and installation.

Table 4-1 Accessories

No.	Name	Quantity	Description
1	Smart Base	1	<p>It is used to fix the device, charge it, realize data communication or connect the device to the client software. It has two types, including network type and USB type.</p> <p> Note The smart base may differ by the model of code reader. The smart base of type IV device only supports fixing and charging the code reader.</p>
2	Cable	1	<p>It is used to wire the device and provide power, and is included in the package.</p> <ul style="list-style-type: none"> • USB type smart base: You should use USB connection cable. • Fast Ethernet smart base: You should use Ethernet connection cable. • Type IV device: Cable is connected via the device's type B connector. <p> Note The cables of different device types are different. Refer to the cables in the package for actual conditions.</p>
3	Power Adapter	1	<p>You should select suitable power adapter according to the device's power supply and consumption. You need to purchase separately.</p> <p> Note Power adapter is required when the USB type device uses power adapter to provide power.</p>
4	Receiver	1	<p>It is inserted into the PC and it is wirelessly connected with the code reader device via the 2.4 G protocol.</p> <p> Note Only the type IV device has this accessory.</p>

4.2 Device Connection

The device realizes communication connection via its smart base, and the smart base has two types, including fast Ethernet type and USB type. Refer to sections below to connect the corresponding device type.

4.2.1 Type II Device

The type II device's smart base has a cable connection port that can be connected to the cable with a 10-pin connector for providing power supply and data transmission.

Note

Due to different smart base types, you should wire and connect the device accordingly.

Network Type Smart Base

Steps

1. Connect 10-pin connector of the cable to the cable connection port of the smart base.
2. Connect RJ45 connector of the cable to a switch or a PC for image debugging or data communication.
3. Connect DC terminal of the cable to a proper power adapter for power supply.
4. (Optional) Connect RS-232 of the cable to the PC if you want to use serial port function.

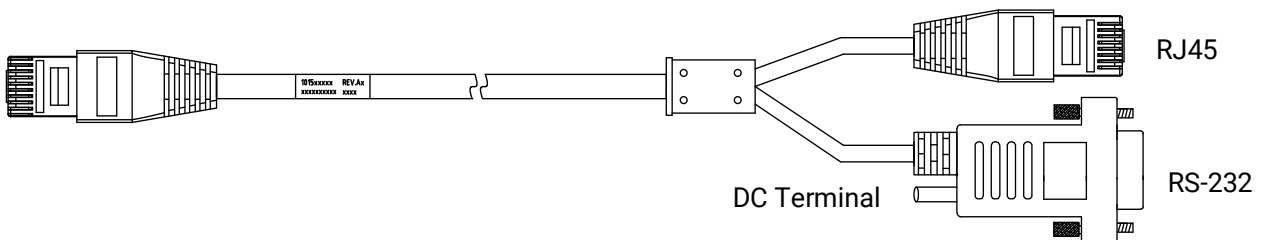

Figure 4-1 Cable for Network Type Smart Base (Type II Device)

5. Use the device to scan the Bluetooth pairing code of the smart base. If you hear prompt sound and the device's power indicator is in orange color, then the device has been connected to the smart base via the Bluetooth.

Note

Press the M button of the smart base for 3 sec to disconnect the connection between the device and the smart base, and then the smart base is in standby status.

6. (Optional) Press the P button of the smart base for 3 sec, and the smart base sends Find Me command to the device. After receiving the commands, the device's status indicator is

flashing red for three times and buzzer beeps three times with interval of 1.5 sec.

Note

Press the P button of the smart base for 3 sec again, and the smart base stops sending Find Me command.

USB Type Smart Base

For USB type smart base, the cable for wiring is shown below.

Steps

1. Connect 10-pin connector of the cable to the cable connection port of the smart base.
2. Connect USB port of the cable to a PC.
3. Connect DC terminal of the cable to a proper power adapter for power supply.

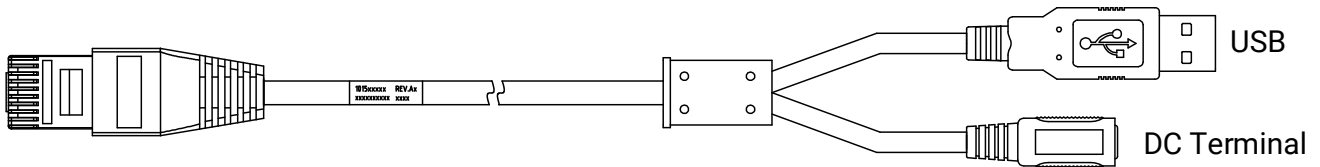

Figure 4-2 Cable for USB Type Smart Base (Type II Device)

4. Use the device to scan the Bluetooth pairing code of the smart base. If you hear prompt sound and the device's power indicator is in orange color, then the device has been connected to the smart base via the Bluetooth.
-

Note

Press the M button of the smart base for 3 sec to disconnect the connection between the device and the smart base, and then the smart base is in standby status.

5. (Optional) Press the P button of the smart base for 3 sec, and the smart base sends Find Me command to the device. After receiving the commands, the device's status indicator is flashing red for three times and buzzer beeps three times.
-

Note

Press the P button of the smart base for 3 sec again, and the smart base stops sending Find Me command.

4.2.2 Type III Device

The type III device's smart base has a power interface and data interface separately. The DC terminal is connected to the power interface, and 10-pin connector is connected to the data

interface for data transmission.

Note

Due to different smart base types, you should wire and connect the device accordingly.

Network Type Smart Base

Steps

1. Connect the smart base to a power adapter via the power interface.
2. Connect 10-pin connector of the cable to the cable connection port of the smart base.
3. Connect RJ45 connector of the cable to a switch or a PC for image debugging or data communication.
4. (Optional) Connect RS-232 of the cable to the PC if you want to use serial port function.

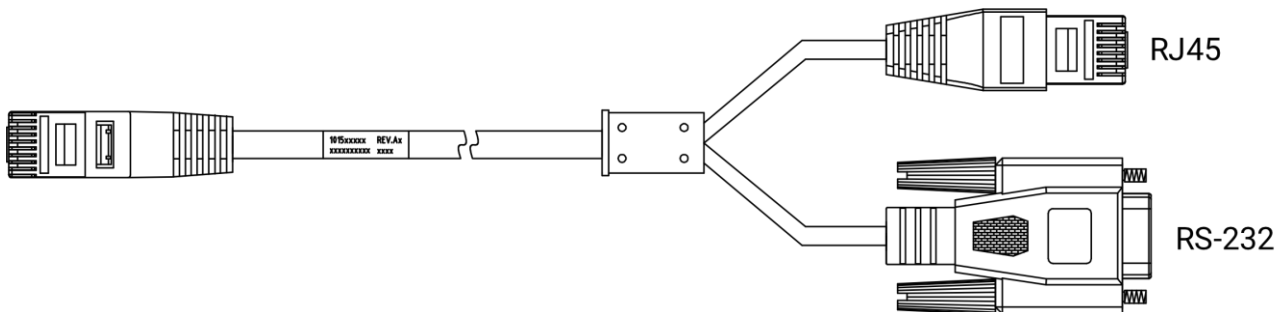

Figure 4-3 Cable for Network Type Smart Base (Type III Device)

5. Use the device to scan the Bluetooth pairing code of the smart base. If you hear prompt sound and the device's power indicator is in yellow color, then the device has been connected to the smart base via the Bluetooth.

Note

Press the button of the smart base for 3 sec to disconnect the connection between the device and the smart base, and then the smart base is in standby status.

6. (Optional) Shortly press the button of the smart base for less than 3 sec, and the smart base sends Find Me command to the device. After receiving the commands, the device's status indicator is flashing red for three times and buzzer beeps three times with interval of 1.5 sec.

Note

Shortly press the button of the smart base for less than 3 sec again, and the smart base stops sending Find Me command after you hear prompts. You can also press the device's trigger switch for less than 3 sec to stop calling.

USB Type Smart Base

Steps

1. Connect the smart base to a power adapter via the power interface.
-

Note

No power adapter connection is required if the USB interface of the cable provides power.

2. Connect 10-pin connector of the cable to the cable connection port of the smart base.
3. Connect USB port of the cable to a PC.



Figure 4-4 Cable for USB Type Smart Base (Type III Device)

4. Use the device to scan the Bluetooth pairing code of the smart base. If you hear prompt sound and the device's power indicator is in yellow color, then the device has been connected to the smart base via the Bluetooth.
-

Note

Press the button of the smart base for 3 sec to disconnect the connection between the device and the smart base, and then the smart base is in standby status.

5. (Optional) Shortly press the button of the smart base for less than 3 sec, and the smart base sends Find Me command to the device. After receiving the commands, the device's status indicator is flashing red for three times and buzzer beeps three times with interval of 1.5 sec.
-

Note

Shortly press the button of the smart base for less than 3 sec again, and the smart base stops sending Find Me command after you hear prompts. You can also press the device's trigger switch for less than 3 sec to stop calling.

4.2.3 Type IV Device

The type IV device supports two kinds of connection methods, including connection via code reader and connection via smart base.

Connection via Code Reader

The type IV device supports direct connection to PC via the supplied cable.

Steps

1. Connect type-B connector of the USB cable to the device's type-B connector.
2. Connect the other end of the USB cable to a PC.

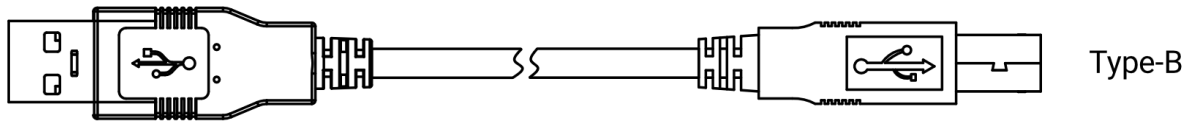

Figure 4-5 Cable for Type IV Device

3. (Optional) Use the receiver if you need to transmit data only.

Connection via Smart Base

The type IV device also supports connection to PC via the smart base.

Steps

1. Connect type-B connector of the USB cable to the smart base's type-B connector.
2. Connect the other end of the USB cable to a PC.
3. (Optional) Use the receiver if you need to transmit data only.
4. Put the device into the smart base for power supply.

4.3 Install Smart Base

Note

Only the type II and type IV devices' smart base supports installation.

You can fix and install the smart base to a plane and put the device into the smart base when it is not in use.

4.3.1 Type II Device

Before you start: Make sure that the wiring and connection of the smart base is done.

Steps

1. Drill four holes in a plane according to the smart base's holes.
2. Install screws into four holes.

Note

Refer to the smart base's specification for specific hole locations.

3. Align the smart base with four holes on the plane via the smart base's holes.

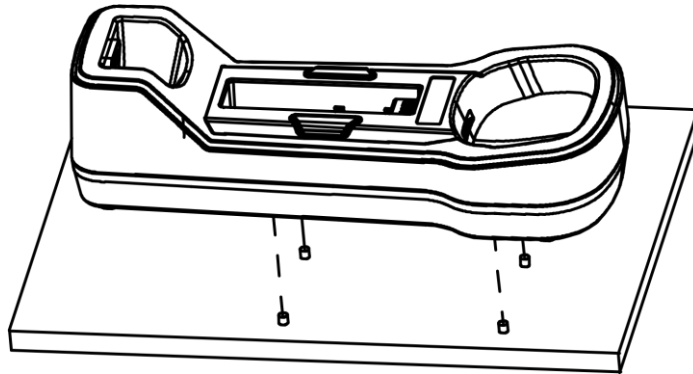

Figure 4-6 Install Smart Base

4. Slide the smart base towards the right to fix the smart base.
5. Put the device into the smart base after the device finishes reading codes.

4.3.2 Type IV Device

The type IV device's smart base has two installation holes for fixing, and you can use these two holes to fix the smart base to a plane.

Note

Refer to the smart base's specification for specific hole locations.

4.4 Charge Device

The charge method varies by different device types.

- Type II device supports both battery charging and direct device charging via smart base.
- Type III device supports direct device charging via smart base only.
- Type IV device supports charging via the USB cable, including direct device charging and smart base charging.

4.4.1 Type II and Type III Devices

The smart base can charge the device, and it offers two charging methods, including battery charging and direct device charging.

Note

- The device will shut down automatically if its battery level is lower than 4 %.
 - The device will have low battery level prompts, that is, buzzer beeps once and vibrator vibrates once every 30 sec if battery level is lower than 10%. The low battery level prompts will stop automatically once you put the device into the smart base.
-

Device Charging

Before you start: Make sure that the cable of the smart base has been connected to external power supply before direct device charging.

Put the device into the smart base, and connection between the device and the smart base is done after you hear prompt sound once.

During charging, the indicator is flashing red if the battery level is lower than 40%, is flashing orange if the battery level is between 40% and 80%, and is flashing green if the battery level is between 80% and 100%. The indicator is solid green when the battery level reaches 100% (Bluetooth is not connected) or is solid orange (Bluetooth is connected).

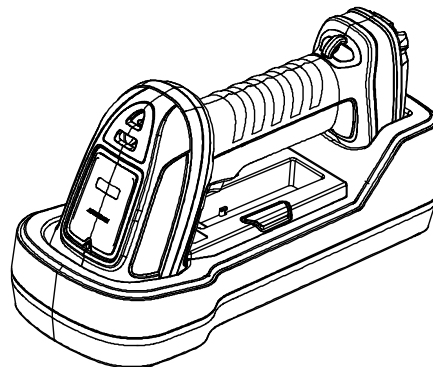

Figure 4-7 Device Charging

Note

- Make sure that the smart base is connected to external power supply before charging.
 - The type II device is charged in priority when the device and battery are in the smart base at the same time. After the device is fully charged, then the battery will be charged.
-

Battery Charging

Take out battery from the device first, and then put it into the smart base for charging.

Before you start: Make sure that the cable of the smart base has been connected to external

power supply before charging.

Steps

1. Slide battery locker of the device.

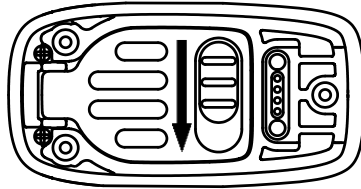

Figure 4-8 Slide Locker

2. Take out battery from the device.

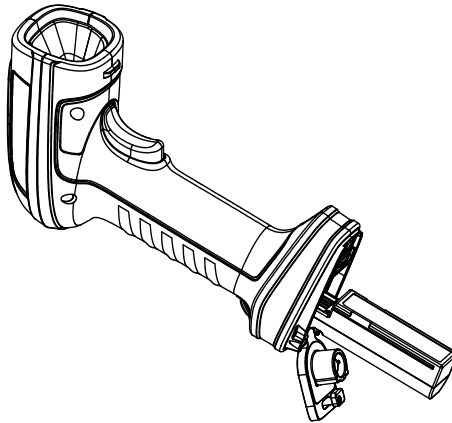

Figure 4-9 Take out Battery

3. Put the battery into the battery holder of the smart base for charging.

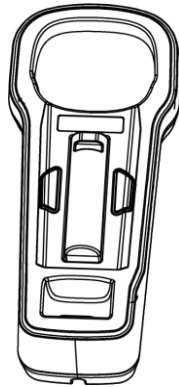

Figure 4-10 Fix Battery

Note

The indicator is flashing red if the battery level is lower than 40% during charging, is flashing orange if the battery level is between 40% and 80%, and is flashing green if the battery level is between 80% and 100%. The indicator is solid green when the battery level reaches 100% (Bluetooth is not connected) or is solid orange (Bluetooth is connected).

4. Take out battery from the holder after full charged, and put it into the device.

4.4.2 Type IV Device

You can use the provided USB cable to charge the type IV device, including direct device charging and smart base charging.

- Direct device charging: Use the provided USB cable to connect device for charging.
- Smart base charging: Use the provided USB cable to connect the smart base and put the device into the smart base for charging.

The device's indicator status during charging is shown below:

- The indicator is flashing red if the device's battery level is between 0% and 40%.
- The indicator is flashing orange if the device's battery level is between 40% and 80%.
- The indicator is flashing green if the device's battery level is between 80% and 100%.

4.5 Basic Operation

Before you start: Make sure cables of the smart base are properly wired, and Bluetooth pairing between the device and the smart base is done. Besides, make sure that the battery level is enough.

The code reading operations of the device are as follows.

Note

- Before using other setting codes, you need to scan **Enable Setting Codes** first to activate the function of setting codes.
 - After the device is connected to the IDMVS client software, you need to click  on the control toolbar to start acquiring images before code reading.
-

Steps

1. Set the device's parameters via reading corresponding setting codes, IDMVS client software, or IDPS.
-

Note

- After connection between the device and the smart base via Bluetooth, you can set the device's parameters after connecting it to the client software via smart base.
 - You can set the device's parameters via letting the device aim at corresponding setting codes, and press the trigger switch. Refer to section **Setting Codes** for details. If the device beeps twice with vibration and meanwhile its STS indicator turns to green, and then parameters are configured successfully and release the trigger switch.
 - Device connection via 2.4G RF. Connect the receiver to the PC, and configure the relevant parameters of the device via the wireless settings module management tool of the IDPS software.
-

2. Move the device and let it aim at codes that need to be read, and press the trigger switch.
-

3. Release the trigger switch after the device beeps once and its STS indicator turns to green, and code reading is successfully. The device sends decoded data via its smart base to the PC.

Chapter 5 Client Software Installation and Operation

After the device and the smart base is connected via the Bluetooth, you can view images acquired by the device and decoded code information, and set parameters of the device and smart base.

Note

The client software displays parameters of the smart base only if the device is not connected to the smart base via the Bluetooth.

5.1 Install Client Software

Steps

Note

- The client software is compatible with 32/64-bit Windows XP/7/10.
 - It is recommended to install the latest version of the client software, and you can download the installation package from <https://en.hikrobotics.com/>.
 - The USB type smart base supports IDMVS V2.3.0 and above only that has integrated USB drive.
 - The graphic user interface may differ by versions of client software you use.
-

1. Double click the installation package to start installing the client software.
2. Select the language.
3. Read and check **Terms of the License Agreement**.
4. Click **Start Setup**.
5. Select installation directory and click **Next**.

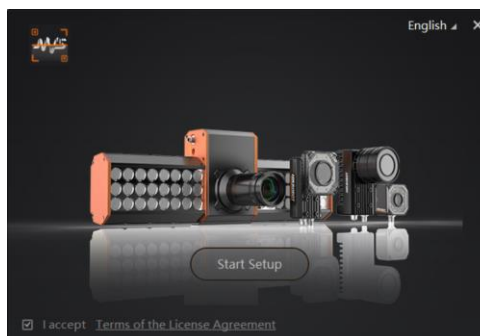

Figure 5-1 Installation Interface

6. Finish the installation according to the interface prompts.

5.2 Set PC Environment

To ensure stable client running and data transmission, you are recommended to set PC environment. For the network type smart base, you need to turn off the firewall and set PC network. For the USB type smart base, you need to check the USB drive on the PC.

5.2.1 Turn off Firewall for Network Type Smart Base

Steps

Note

For different Windows versions, the path name or interface may differ. Please refer to the actual condition.

1. Go to Windows Firewall.
 - Windows XP system: Click **Start** → **Control Panel** → **Security Center** → **Windows Firewall**.
 - Windows 7 system: Click **Start** → **Control Panel** → **Windows Firewall**.
 - Windows 10 system: Click **Start** → **Control Panel** → **System and Security** → **Windows Defender Firewall**.
2. Click **Turn Windows Defender Firewall on or off** on the left.
3. Select **Turn off Windows Defender Firewall (not recommended)**.

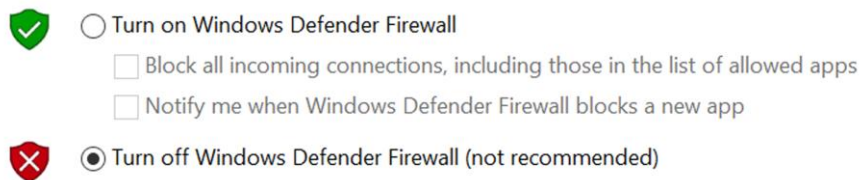

Figure 5-2 Windows Defender Firewall

4. Click **OK**.

5.2.2 Set PC Network for Network Type Smart Base

To ensure stable data transmission and normal communication between the PC and the device via client software, you need to set the PC network and make sure that they are in the same network segment.

Steps

Note

For different Windows versions, the specific setting path and interface may differ. Please refer to the actual condition.

1. Go to PC network settings page: **Start** → **Control Panel** → **Network and Internet** → **Network and Sharing Center** → **Change adapter settings**.
2. Select NIC and set the IP obtainment mode.
 - Select **Obtain an IP address automatically** to get an IP address of the PC automatically.
 - Or select **Use the following IP address** to set an IP address for the PC manually.

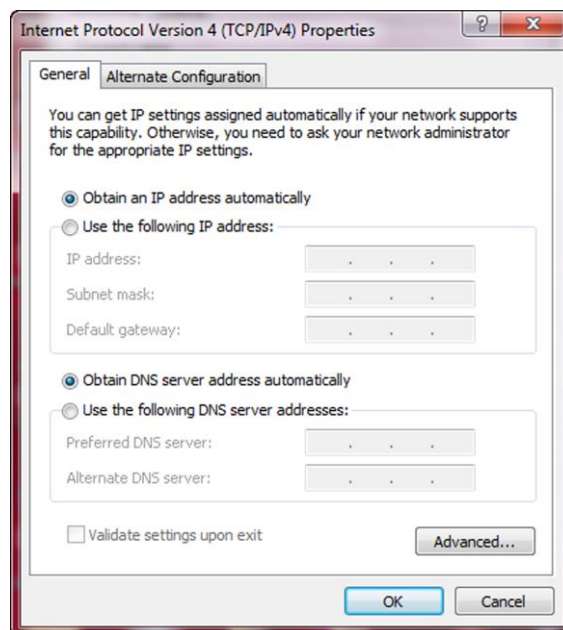

Figure 5-3 Set PC Network

5.2.3 Check USB Drive for USB Type Smart Base

Checking the USB drive on the PC is required before using the USB type smart base. After connecting smart base to the PC, the Windows system will automatically detect a new hardware device and install its corresponding drive.

Go to **Device Manager** by either pressing Win+X or right-clicking on the Windows menu button, and locate and expand the **Network adapters** to check the drive.

Note

- You can use the drive management tool to reinstall the USB drive if the installation is failed.
 - If the installation of USB drive fails, the client software cannot enumerate the smart base.
-

5.3 Set Device Network

You can set and operate the device in the client software only when the device is in the same network segment with the PC where the client software is installed.

Steps

1. Double click the client software to run it.
2. Click  to find the device.
3. Right click the device to be connected.
4. Click **Modify IP**.
5. Set the IP address of the device in the same network segment with the PC.

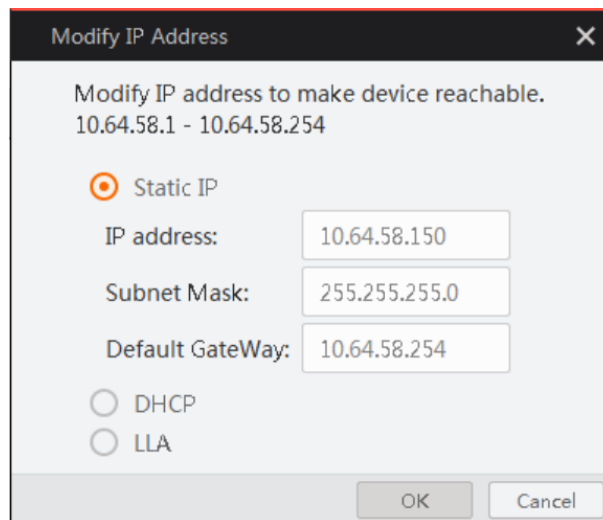



Figure 5-4 Modify IP Address

6. Click **OK**.

5.4 Connect Device to Client Software

Make sure that your device IP address is in the same network segment with the PC where you installed the client software before connecting the device to it.

Double click the device in the device list, or click  to connect the device to the client.

Chapter 6 Client Software Layout

After connecting to the device, the client software can read the device information and display it.

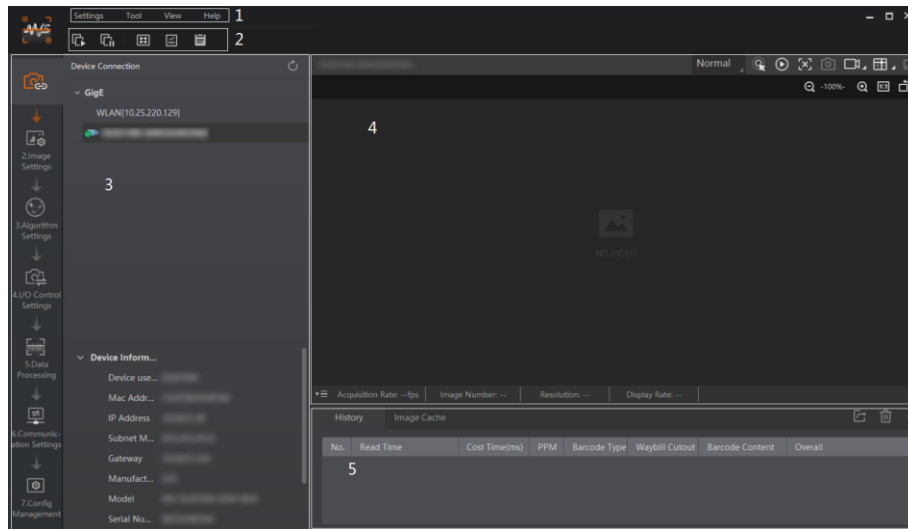

Figure 6-1 Main Window

Note

- The specific interfaces of the client software may differ by its versions.
- Refer to the user manual of the client software for detailed introductions and operations.

Table 6-1 Description of Main Window

No.	Name	Description
1	Menu Bar	The menu bar displays function modules, including Settings , Tool , View , and Help .
2	Control Toolbar	The control toolbar provides quick operations for the device. You can click different icons to start or stop batch acquisition, change window layout, view statistics information, and device log.
3	Device Configuration Area	You can connect or disconnect device, set parameters, and modify device IP address in this area.
4	Live View Window	This area displays the acquisition images and algorithm reading result in real-time. You can click different icons to capture and save image, record, etc.
5	History Record	This area displays different barcode information read by the device in real-time.

You can set device parameters in device configuration area.

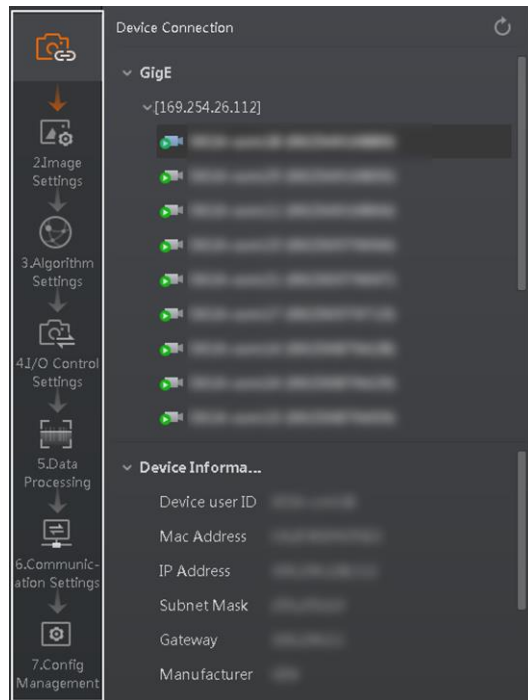

Figure 6-2 Device Configuration Area

Table 6-2 Configuration Area Description

No.	Module Name	Description
1	Device Connection	You can connect or disconnect device, modify device IP address, view device information, etc.
2	Image Settings	You can set image parameters, light parameters, etc.
3	Algorithm Settings	You can add different barcodes, set barcode number, etc.
4	I/O Control Settings	You can set parameters related with input and output.
5	Data Processing	You can set filter rule for output result.
6	Communication Settings	You can select different communication protocols, and set related parameters for output result.
7	Configuration Management	You can save and load user parameters, and restart the device.

Chapter 7 Device Mode Settings

The device supports 3 types of operating modes, including **Test**, **Normal**, and **Raw**. You can select different modes in live view window according to actual demands.

Note

- Stopping the real-time acquisition is required before selecting modes.
- You need to set device mode as **Normal** before specific device settings. Otherwise, the device parameters may be different.

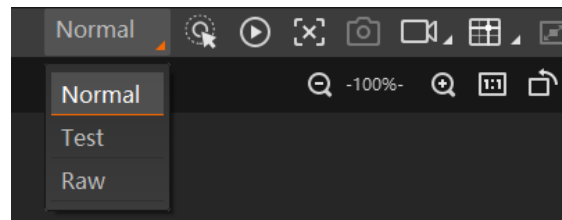



Figure 7-1 Select Device Mode

Table 7-1 Device Mode Description

Device Mode	Description
Test Mode	It is used during device debugging. The device outputs images that are acquired in real-time, and displays code information.
Normal Mode	It is used during device normal operation. After reading code in image, the device outputs image and code information.
Raw Mode	It is used during testing image data. The device outputs raw data and displays code information.

You can click  in live view window to view images and code reading effect. If the effect is not very good, you can adjust related parameters like exposure time, gain, etc. in the **Image Settings** area.

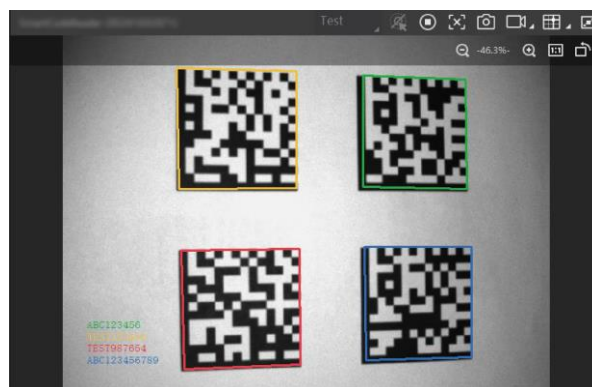

Figure 7-2 Code Reading

Chapter 8 Setting Codes

8.1 Introduction

The device supports configuring parameters via reading special codes that are called setting codes. Here we introduce common setting codes.

Note

Before using other setting codes, you need to scan **Enable Setting Codes** first to activate the function of setting codes.



Figure 8-1 Setting Codes Introduction

Table 8-1 Device Mode Description



No.	Description
1	It is the code part of the setting code. After reading this part, the device can finish the corresponding parameter settings.
2	**stands for the default settings.
3	It is the content of setting codes.

Via reading setting codes, the device can set enable/disable settings, set code type, set code reading mode, set quantity of code reading, set data processing, set aiming system, set light source, set buzzer, set vibration, set code color, etc.

8.2 Enable/Disable Setting Codes

Before using other setting codes, you need to scan **Enable Setting Codes** first to activate the function of setting codes. Scan **Disable Setting Codes** to exit setting codes function.









Table 8-2 Enable/Disable Setting Codes













Function	Setting Codes	Function	Setting Codes
Enable Setting Codes		Disable Setting Codes	













8.3 Set Setting Codes of Code Type



The device can be set what code type to be read via reading specific setting codes. Currently, the device supports Code 39, Code 93, Code 128, CodeBar, ITF 25, ITF 14, EAN 8, EAN 13, UPCA, UPCE, QR Code, Data Matrix, etc.

Table 8-3 Set Setting Codes of Code Type

Function	Setting Codes	Function	Setting Codes
Enable All 1D Codes		Disable All 1D Codes	
Enable All 2D Codes		Disable All 2D Codes	
Enable Code 39		Disable Code 39	
Enable Code 128		Disable Code 128	

Function	Setting Codes	Function	Setting Codes
Enable Code 93		Disable Code 93	
Enable CodeBar		Disable CodeBar	
Enable ITF 14		Disable ITF 14	
Enable ITF 25		Disable ITF 25	
Enable EAN 8		Disable EAN 8	
Enable EAN 13		Disable EAN 13	





Function	Setting Codes	Function	Setting Codes
Enable UCPA		Disable UCPA	
Enable UCPE		Disable UCPE	
Enable QR Code		Disable QR Code	
Enable Data Matrix		Disable Data Matrix	
Enable Micro QR Code		Disable Micro QR Code	
Enable AZTEC Code		Disable AZTEC Code	

Function	Setting Codes	Function	Setting Codes
Enable PDF417 Code		Disable PDF417 Code	

8.4 Set Setting Codes of Code Reading Mode

The device supports setting different code reading modes via scanning setting codes, including common mode, accurate mode, continuous mode, and batch mode.

Table 8-4 Set Setting Codes of Code Reading Mode

Function	Setting Codes	Function	Setting Codes
Common Mode		Accurate Mode	
Continuous Mode		Batch Mode	

8.5 Set Setting Codes of Code Reading Quantity

You can set the device's code reading quantity via scanning the specific setting codes as shown below.

Steps

1. Read setting codes of editing quantity of code reading.



Figure 8-2 Edit Quantity of Code Reading

2. Read the corresponding digital codes according to actual demands.

Note



- The quantity of code reading is related with code reading mode.
- If the code reading mode is batch mode and the quantity of code reading is smaller than or equal to 21, you should scan the digital code of tens digit first, and then scan the single digit. If the quantity of code reading is single digit, the digital code of tens digit is 0. For example, if the quantity of code reading is 12, scan the digital code of 1 first, and then scan 2.
- If the code reading mode is continuous mode, the quantity of code reading is not limited. You should scan the digital code in the first place, and then scan the digital code in the second place, etc. For example, if the quantity of code reading is 530, scan 5 first, and then 3, and 0 at last.









3. Read the setting codes of saving to save the parameter settings.



Figure 8-3 Setting Codes of Saving

Table 8-5 Digital Codes

Function	Setting Codes	Function	Setting Codes
Digital Code 0		Digital Code 1	

Function	Setting Codes	Function	Setting Codes
Digital Code 2		Digital Code 3	
Digital Code 4		Digital Code 5	
Digital Code 6		Digital Code 7	
Digital Code 8		Digital Code 9	





8.6 Set Setting Codes of Data Processing

You can set the device's outputted code results via scanning the specific setting codes as shown below.

Steps



1. Read setting codes of enabling prefix or suffix.

Table 8-6 Setting Codes of Enabling Prefix or Suffix

Function	Setting Codes	Function	Setting Codes
Enable Prefix		Disable Prefix	
Enable Suffix		Disable Suffix	

2. Read setting codes of editing prefix or editing suffix.

Table 8-7 Setting Codes of Editing Prefix or Suffix



Function	Setting Codes	Function	Setting Codes
Edit Prefix		Edit Suffix	

3. Set prefix and suffix characters according to actual demands, find the corresponding hexadecimal code value in ASCII table (see **Appendix A ASCII Table** for details), and read the corresponding digital codes. For example, if the defined prefix and suffix content is *, the corresponding ASCII code is 2a. Use to the device to read the digital code 2 and digital code a in turn.

 **Note**

Up to ten setting codes can be read.

Table 8-8 Setting Codes of a to f

Function	Setting Codes	Function	Setting Codes
Digital Code a		Digital Code b	











Function	Setting Codes	Function	Setting Codes
Digital Code c		Digital Code d	
Digital Code e		Digital Code f	

Table 8-9 Setting Codes of Data Processing

Function	Setting Codes	Function	Setting Codes
Enable Stop Text		Disable Stop Text	
Edit Stop Text		Enable Newline	
Disable Newline		Enable Enter	
Disable Enter		--	--

4. Read the setting codes of saving to save the parameter settings.











Figure 8-4 Setting Codes of Saving

8.7 Set Setting Codes of Aiming System

The aiming system is used to locate codes in the field of view to help read codes easily. The setting codes of aiming system can enable, disable, delay or set delay time of the aiming system.

Table 8-10 Set Setting Codes of Aiming System

Function	Setting Codes	Function	Setting Codes
Enable Aiming System		Disable Aiming System	
Enable Aiming System Delay		Disable Aiming System Delay	
Set Delay Time 1 s		Set Delay Time 2 s	

Function	Setting Codes	Function	Setting Codes
Set Delay Time 5 s		Set Delay Time 10 s	







8.8 Set Setting Codes of Light Source





The setting codes of light source can enable or disable the light source, set polling interval, etc. After enabling **Light Polling**, you can let red and while light sources polling alternately in accordance with configured interval when code reading succeeds or before ending trigger.

 **Note**

By default, the polling interval is 2 s.

Table 8-11 Set Setting Codes of Light Source



Function	Setting Codes	Function	Setting Codes
Enable Lighting Polling		Disable Lighting Polling	
Set Polling Interval 500 ms		Set Polling Interval 1 s	
Set Polling Interval 2 s		Set Polling Interval 5 s	









Function	Setting Codes	Function	Setting Codes
Set Polling Interval 10 s		Enable White Light	
Disable White Light		Enable Red Light	
Disable Red Light		--	--

8.9 Set Setting Codes of Buzzer

The setting codes of buzzer can enable or disable the buzzer function, set its duration, etc.

Table 8-12 Set Setting Codes of Buzzer



Function	Setting Codes	Function	Setting Codes
Enable Buzzer When Device Powers On		Disable Buzzer When Device Powers On	







Function	Setting Codes	Function	Setting Codes
Enable Buzzer When Reading Codes		Disable Buzzer When Reading Codes	
Set Buzzer Duration 1 s		Set Buzzer Duration 2 s	
Set Buzzer Duration 3 s		Set Buzzer Duration 50 ms	
Set Buzzer Duration 100 ms		Set Buzzer Duration 150 ms	

8.10 Set Setting Codes of Vibration

The setting codes of vibration can enable or disable the vibration function, set its duration, etc.

Table 8-13 Set Setting Codes of Vibration

Function	Setting Codes	Function	Setting Codes
Enable Vibration		Disable Vibration	

Function	Setting Codes	Function	Setting Codes
Set Vibration Duration 100 ms		Set Vibration Duration 200 ms	
Set Vibration Duration 300 ms		Set Vibration Duration 500 ms	
Set Vibration Duration 1 s		Set Vibration Duration 2 s	











8.11 Set Setting Codes of USB Communication

After the device is connected to the USB type smart base, and you can scan setting codes of USB communication to enable or disable the USB communication function, set baud rate, etc.

Note

- USB communication is supported only after the device is connected to the USB type smart base.
- By default, the device's communication is USB keyboard. By reading specific setting codes, the device's communication method can be switched to USB CDC.
- After switching communication method, the device will restart.







Table 8-14 Set Setting Codes of USB Communication

Function	Setting Codes	Function	Setting Codes
Enable USB Communication		Disable USB Communication	
USB HID Communication Mode		USB CDC Communication Mode	
Set Baud Rate as 4800		Set Baud Rate as 9600	
Set Baud Rate as 19200		Set Baud Rate as 38400	
Set Baud Rate as 57600		Set Baud Rate as 115200	

8.12 Set Setting Codes of Switching Bluetooth Mode

The device and smart base are connected via Bluetooth, and the connected Bluetooth mode supports switching via reading the setting codes, and supports deleting pairing information.



Table 8-15 Set Setting Codes of Switching Bluetooth Mode

Function	Setting Codes	Function	Setting Codes
Request Setting Bluetooth as Main Mode		Confirm Setting Bluetooth as Main Mode	
Request Setting Bluetooth as HID Mode		Confirm Setting Bluetooth as HID Mode	
Request Deleting Pairing Information		Confirm Deleting Pairing Information	

8.13 Set Setting Codes of Code Color

The setting codes of code color include white code on black wall and black code on white wall.





Table 8-16 Set Setting Codes of Code Color



Function	Setting Codes	Function	Setting Codes
Black Code On White Wall		White Code On Black Wall	
Self-Adaptive		--	--

8.14 Set Setting Codes of Trigger

The setting codes of trigger can let the device switch the trigger mode, including pressing trigger switch, self-trigger, response trigger, and support disabling trigger mode.

Table 8-17 Set Setting Codes of Trigger

Function	Setting Codes	Function	Setting Codes
Disable Trigger Mode		Press Trigger Switch	
Self-Trigger		Response Trigger	

Function	Setting Codes	Function	Setting Codes
High Sensitivity		Middle Sensitivity	
Low Sensitivity			

8.15 Set Setting Codes of Device Information

The setting codes of device information can help you get the device's information, including version No., algorithm version, hardware version, serial No., and send you the device's name.

Table 8-18 Set Setting Codes of Device Information





Function	Setting Codes	Function	Setting Codes
Get Version No.		Get Algorithm Version	
Get Hardware Version		Get Serial No.	

Function	Setting Codes	Function	Setting Codes
Send Device Name			

8.16 Set Setting Codes of Management

The setting codes of management can save or initialize user parameters, restart the device, etc.

Table 8-19 Set Setting Codes of Management

Function	Setting Codes	Function	Setting Codes
Save		Switch Default Parameters to	
Request to Restore Factory Settings		Confirm Restore Factory Settings to	
Restart		--	--

Chapter 9 Device Settings

9.1 Feature Tree Introduction

Note

The feature tree may differ by device models.

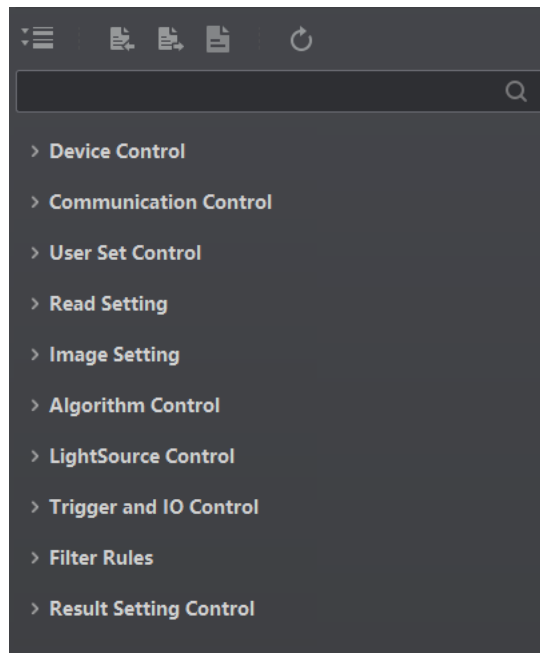

Figure 9-1 Feature Tree

Table 9-1 Feature Tree Description

No.	Module Name	Description
1	Device Control	You can view device information, edit its name, restart it, etc.
2	Communication Control	You can select different communication protocols, and set related parameters for output result.
3	User Set Control	You can save and load user parameters, and restart the device.
4	Read Setting	You can set the device mode and select code types.
5	Image Setting	You can set exposure, gain, Gamma, frame rate, etc.
6	Algorithm Control	You can set algorithm parameters of codes.
7	Light Source Control	You can select the device’s light source type and set parameters.

No.	Module Name	Description
8	Trigger and IO Control	You can set parameters related with input and output.
9	Filter Rules	You can set filter rule for output result.
10	Result Setting Control	You can set parameters for output information.

9.2 Code Reading Mode Settings

The device supports different code reading modes, including common mode, accurate mode, continuous mode, and batch mode.

Steps

1. Right click the device in **Device Connection**, and click **Feature Tree**.
2. Go to **Trigger and IO Control** → **Read Code Method**, and select it according to actual demands.

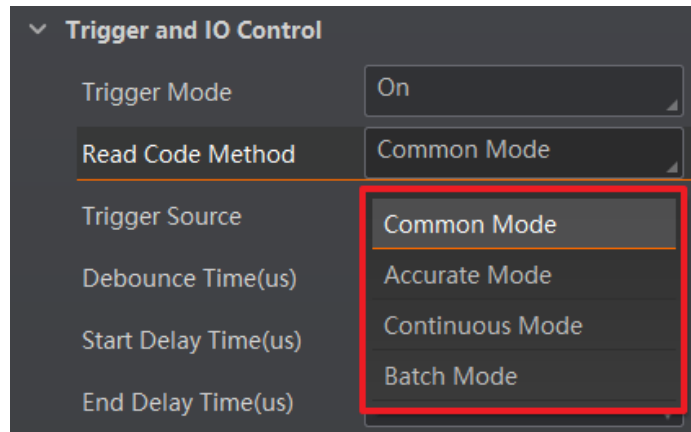

Figure 9-2 Code Reading Mode Settings

Table 9-2 Parameters Description

Code Reading Mode	Description
Common Mode	It reads codes that are closest to the cross laser center only. The code reading process ends if codes are read successfully or the trigger switch is released.
Accurate Mode	It reads codes containing the cross laser center in the code area only. The code reading process ends if codes are read successfully or the trigger switch is released.
Continuous Mode	It reads codes containing the cross laser center in the code area only. The device reads codes continuously when the trigger switch is pressed and ends reading when the switch is switched.

Code Reading Mode	Description
Batch Mode	It can read multiple codes when the trigger switch is pressed. After code reading is finished, the result will be packaged and outputted. The code reading process ends if expected code quantity is reached or exceeded, code reading timed out, valid frame quantity is reached, or the trigger switch is released.

9.3 Device Control Settings

Note

The specific parameters may differ by device models and firmware versions.

Go to **Device Control**, you can view battery value, temperature, and other information of the device and smart base.

9.3.1 Device Parameters

Table 9-3 Device Parameters

Device Parameters	Description
IDH Battery State	It displays the battery state of the device, including Charge and Discharge.
IDH Battery Value	It displays the battery value of the device, ranging from 0% to 100%.
IDH Battery Temperature	It displays the battery temperature of the device.
IDH Battery KeepAlive Timeout	It sets after how much time without operation that the device enters a low consumption mode.
IDH Power Off Timeout (min)	It sets after how much time that the device shuts off from a low consumption mode, and the default time is 30 min. Apart from low consumption MCU, all other power supplies will be closed when the device shuts off.
Battery Manager Version	It displays the battery version of the device.
IDH Ble SoftVersion	It displays the Bluetooth version of the device.
IDH Ble Sig Strength	It sets the Bluetooth signal intensity of the smart base. <ul style="list-style-type: none"> ● Strong Signal: Bluetooth signal intensity is higher than -40 dBm. ● Medium Signal: Bluetooth signal intensity is between -70 dBm to -40 dBm. ● Low Signal: Bluetooth signal intensity is lower than -40 dBm. ● No Signal: No Bluetooth connection.

Device Parameters	Description
2.4G Software Version	It displays the 2.4G peripheral module version. Only type IV device supports this parameter.
2.4G Connection State	It displays the connection state of the 2.4G peripheral module. Only type IV device supports this parameter.

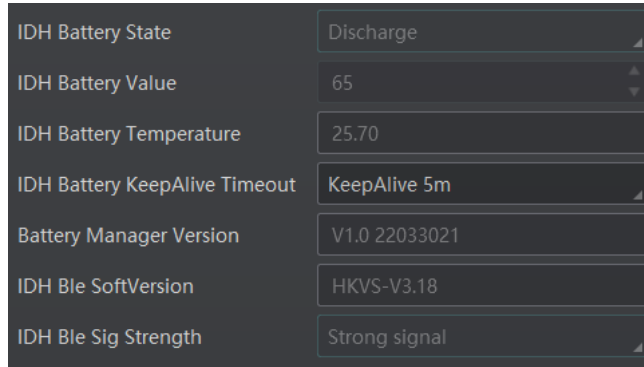

Figure 9-3 Device Parameters

9.3.2 Smart Base Parameters

Table 9-4 Smart Base Parameters

Smart Base Parameters	Description
Connect Status	It displays the connection status between the smart base and the device.
IDA Battery Status	It displays the charging status of the smart base, including Leave, Charge, Discharge, Not Discharge and Not Charge.
IDA Ble SoftVersion	It displays the Bluetooth version of the smart base.
IDA Ble Sig Strength	It sets the Bluetooth signal intensity of the smart base. <ul style="list-style-type: none"> ● Strong Signal: Bluetooth signal intensity is higher than -40 dBm. ● Medium Signal: Bluetooth signal intensity is between -70 dBm to -40 dBm. ● Low Signal: Bluetooth signal intensity is lower than -40 dBm. ● No Signal: No Bluetooth connection.
IDA Ble Sig Strength Value	It displays the Bluetooth signal intensity.
Connected IDH Number	It displays how many devices that the smart base has connected.

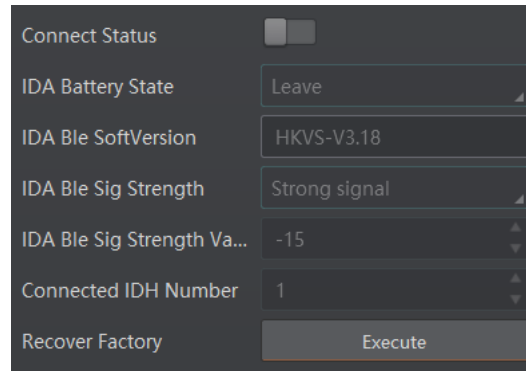

Figure 9-4 Smart Base Parameters

9.4 Prompt Settings

Note

The specific parameters may differ by device models and firmware versions.

The device's buzzer, vibrator, indicator, and buttons of the smart base can be configured via the client software.

9.4.1 Set Buzzer

Go to **Tigger and IO Control**, you can set buzzer parameters of the device after reading codes successfully.

- Buzzer Enable: If it is enabled, you can set buzzer parameters of the device after reading codes successfully.
- Buzzer Duration: It sets the output duration of the buzzer, and unit is ms.
- Buzzer Frequency: It sets output frequency of the buzzer, and unit is hz.

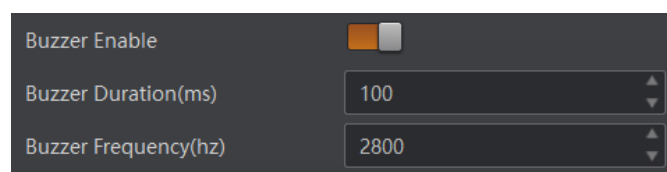

Figure 9-5 Set Buzzer

9.4.2 Set Vibrator

Go to **Tigger and IO Control**, you can set vibrator parameters of the device after reading codes successfully.

- Vibrator Enable: If it is enabled, you can set vibrator parameters of the device after reading codes successfully.
- Bcr Vibrator Duration (ms): It sets the output duration of the vibrator, and unit is ms.

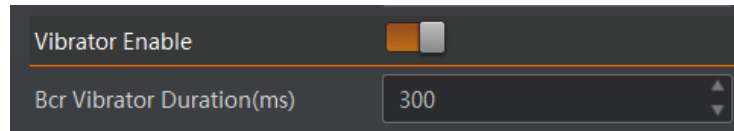

Figure 9-6 Set Vibrator

9.4.3 Set Button of Smart Base

Go to **Device Control**, and you set button of smart base.

Smart Base of Type II Device

- Left Key Enable: It sets the left button of the smart base. After it is enabled, press it for 3 sec to disconnect the connection between the device and the smart base. The smart base is in standby status.
- Right Key Enable: It sets the right button of the smart base. After it is enabled, press it for 3 sec, and the smart base sends **Find Me** command to the device. After receiving the commands, the device will have indicator and buzzer prompts. Press it for 3 sec again, and the smart base stops sending **Find Me** command.



Figure 9-7 Set Button of Smart Base

Smart Base of Type III Device

Ida H30 Key Enable: After it is enabled, the smart base can find the device, and connect or disconnect the device via the Bluetooth.

- Shortly press button on the smart base for less than 3 sec, and the smart base sends Find Me command to the connected device. After receiving the commands, the device will have indicator and buzzer prompts. Shortly press it for less than 3 sec again, and the smart base disconnects connection with the device, and enters standby status.
- Press button on the smart base for more than 3 sec, disconnect the connected device from the smart base via Bluetooth.

9.5 Image Quality Settings

This section introduces how to set image related parameters of the device via client software.

Note

For different models of the device, the specific parameters may differ, and the actual device you purchased shall prevail.

9.5.1 Set Image

You can set different image parameters like exposure time, gain, Gamma, and acquisition frame rate in image parameters.

Note

- Make sure you have select the device to be set in **Device Connection** before setting image parameters.
 - For specific parameter range like exposure time, gain and acquisition frame rate, refer to the device's specification for details.
-

Exposure Time

You can increase exposure time to improve image brightness.

Note

To some extent, increasing exposure time will reduce acquisition frame rate, and impact image quality.

Gain

You can increase gain to improve image brightness.

Note

To some extent, increasing gain will create more image noises, and impact image quality.

Gamma

Gamma allows you to adjust the image contrast. It is recommended to reduce Gamma to increase brightness in dark background.

Acquisition Frame Rate

Acquisition frame rate refers to the image number that is acquired by the device per second.

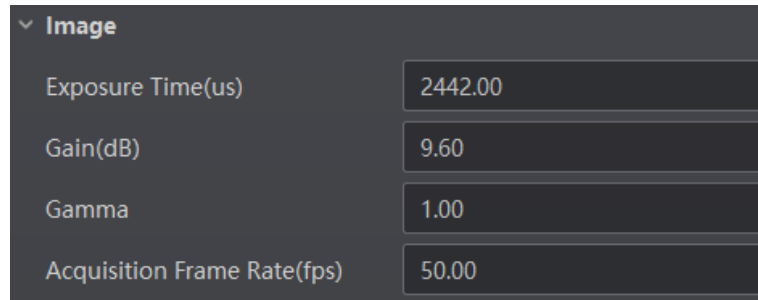

Figure 9-8 Set Image

9.5.2 Set Exposure

The device supports two types of exposure modes, including off and continuous. Refer to the table below for details.

Steps

1. Right click the device in **Device Connection**, and click **Feature Tree**.
2. Go to **Image Setting** → **Exposure Auto**, and select it according to actual demands.

Table 9-5 Exposure Mode

Exposure Auto	Description
Off	The device exposures according to the value configured by the user in Exposure Time (μs) .
Continuous	The device adjusts the exposure time continuously according to the image brightness.

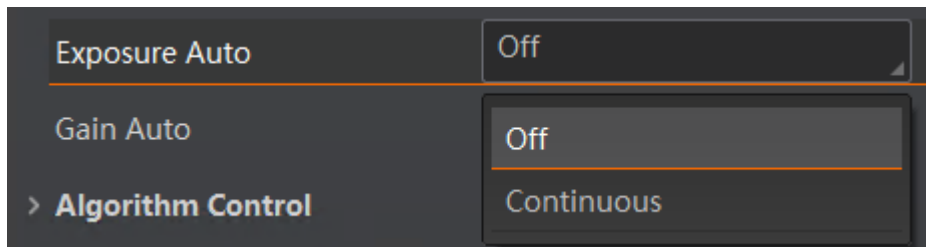

Figure 9-9 Set Exposure

9.5.3 Set Gain

The device supports two types of gain modes, including off and continuous. Refer to the

table below for details.

Steps

1. Right click the device in **Device Connection**, and click **Feature Tree**.
2. Go to **Image Setting** → **Gain Auto**, and select it according to actual demands.

Table 9-6 Gain Mode

Gain Auto	Description
Off	The device adjust gain according to the value configured by the user in Gain (dB) .
Continuous	The device adjusts gain continuously according to the image brightness.

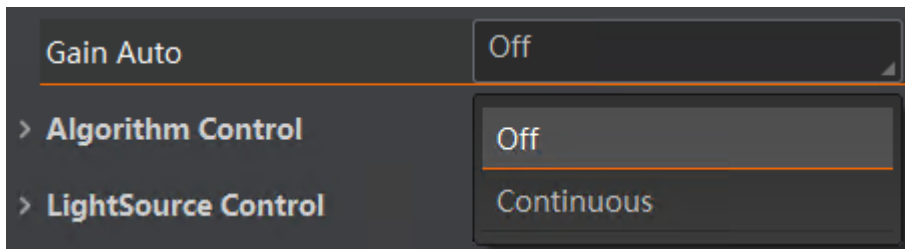

Figure 9-10 Set Gain

9.5.4 Set Light Source

Light source control allows you to enable the device’s aiming system and light source, and set related parameters according to actual demands.

Note

- Light source parameters may differ by device models.
- Make sure you have selected the device to be set in **Device Connection** before setting light source parameters.

Type II Device

Laser Enable

It enables or disables the device’s cross laser.

Laser Delay Enable

After enabling this parameter, you can enter **Laser Delay Duration** to delay the close time of the cross laser.

Light Polling

After enabling, red and while light sources will polling alternately in accordance with configured interval when code reading succeeds or before ending trigger.

White Light Enable

After enabling, the white light source is available.

Note

You should disable **Light Polling** first.

Red Light Enable

After enabling, the red light source is available.

Note

- You should disable **Light Polling** and **White Light Enable** first.
 - After disabling **Light Polling**, the device uses red light source by default.
-

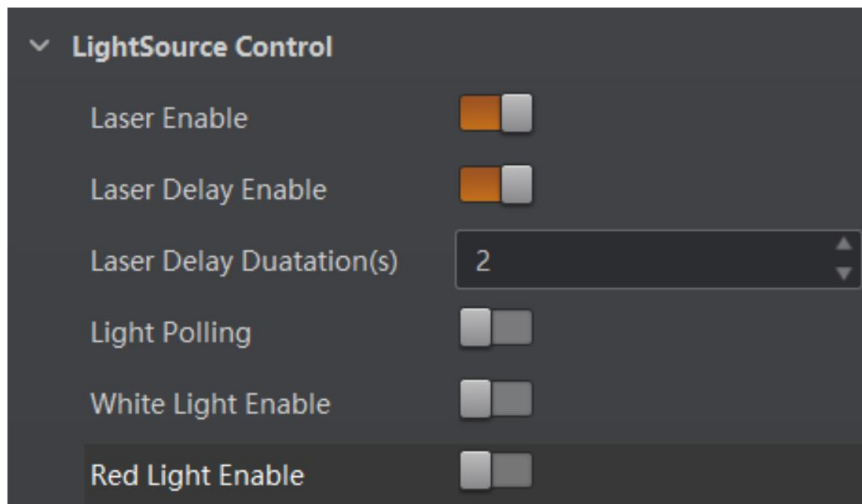

Figure 9-11 Set Light Source

Type III Device

Laser Enable

It enables or disables the device's cross laser.

Laser Delay Enable

After enabling this parameter, you can enter **Laser Delay Duration** to delay the close time of the cross laser.

Light Enable

After enabling, the light source is available.

9.5.5 Set Mirror X

The device supports the mirror X function. If this function is enabled, the image will be reversed in a horizontal way. Go to **Image Settings**, click **All Features** to display other

features, and set **Mirror X** according to actual demands.

Note

This function is enabled by default, and it may differ by device models.

9.5.6 Set Test Pattern

Test pattern helps troubleshooting image problems and images in the test pattern are only for test. When exceptions occur in images acquired by the device in real time, you can check if images in the test pattern have similar problems to determine the cause of an exception.

Note

- The test pattern is available in the test or raw device mode.
 - Specific parameters of this function may differ by device models.
-

Go to **Image Settings**, click **All Features**, find **Test Pattern** in **Other Features**, and set **Test Pattern** according to actual demands.

9.6 Code Algorithm Settings

The code reader supports reading multiple types of 1D code and 2D code, and you can add and set code parameters via the client software.

9.6.1 Add Code

Adding code before you set code parameters via the client software. In **Algorithm Settings**, you can add different types of codes according to actual demands.

In **Algorithm Settings**, click **Add Barcode**, select the types of codes to be read, and set the **1D Code Number** and **2D Code Number** according to actual demands.

Note

- For different models of the device, the specific parameters may differ, and the actual device you purchased shall prevail.
 - Selected symbology amount and added code amount may affect the code recognition time. Note that selecting more symbologies or adding more codes may consume more time to recognize codes in the image.
 - No matter 1D code or 2D code, up to 20 codes can be added at a time. Note that adding more codes may consume more time to recognize codes in the image. Therefore, the code number is recommended to be set according to the actual demands.
 - The code reader may output actual code number when the mismatch between the actual code number and the code number set in the client software occurs.
-



Figure 9-12 Add Codes

9.6.2 Set Algorithm Parameter

Click **All Features** on the upper-right to display all algorithm parameters.

Note

For different models of the device, the specific parameters may differ, and the actual device you purchased shall prevail.

Timeout Value

Timeout value refers to the maximum running time of algorithm, and its unit is ms. The code reader will stop parsing the images and return results if the time is exceeded the waiting time configured.

Code Color

It defines the readable code color. **White Code On Black Wall** means that the client software can recognize the white code with black background. **Black Code On White Wall** means that the client software can recognize the black code with white background. **Adaptive** means that the client software can recognize both the black code with white background, and the white code with black background.

Code 39 Check

Enable this parameter if Code 39 uses the parity bit.

Note

You need to select **Code 39** in **Add Barcode**.

ITF 25 Check

Enable this parameter if ITF 25 uses the parity bit.

Note

You need to select **ITF 25** in **Add Barcode**.

Accurate Timeout Enable

If it is enabled, the accuracy of algorithm timeout will improve.

9.7 Signal Input Settings

Note

The specific parameters may differ by device models and firmware versions.

In the signal input module, you can set the trigger related parameters. In general, the device supports three different trigger sources, including LineIn1 input, response trigger, and self trigger.

- LineIn1 input: Press the trigger switch to let the device trigger.
- Response trigger: When the brightness of the field of view changes, code reading and barcode output are automatically triggered. The device monitors the change of image brightness value in real time and starts code reading when the change exceeds the configured sensitivity threshold.
- Self trigger: The trigger is executed by itself according to the configured trigger time interval and number of times.

9.7.1 Set and Execute Hardware Trigger

Steps

1. Click **I/O Control Settings** → **Input** → **Trigger Mode**.
 2. Select **On** as **Trigger Mode**.
 3. Select **LineIn1** as **Trigger Source**.
 4. Set **Debounce Time**, **Start Delay Time**, **End Delay Time**, and **Line Out Trigger In Polarity** according to actual demands.
-

Note

- Debounce time allows the device to filter out unwanted short external trigger signal that is input to the device.
 - If configured **Debounce Time** is greater than the pulse width of trigger signal, then this trigger signal will be ignored. Otherwise, the trigger signal will be outputted after delay.
-

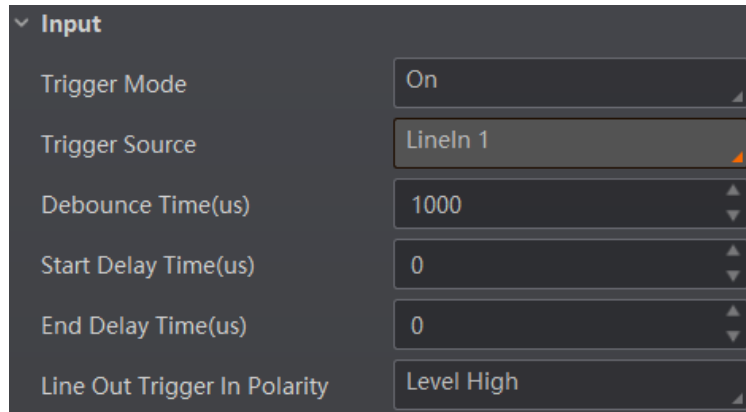

Figure 9-13 Set and Execute Hardware Trigger Mode

9.7.2 Set and Execute Response Trigger

Steps

1. Click **I/O Control Settings** → **Input** → **Trigger Mode**.
2. Select **On** as **Trigger Mode**.
3. Select **Response Trigger** as **Trigger Source**, and set **Trigger Sensitivity** accordingly.

9.7.3 Set and Execute Self Trigger

Before you start: The device cannot execute self trigger if read code method is batch mode. Thus, make sure that the device's read code method is not in batch mode when using self trigger.

Steps

1. Click **I/O Control Settings** → **Input** → **Trigger Mode**.
2. Select **On** as **Trigger Mode**.
3. Select **Self Trigger** as **Trigger Source**, set **Self Trigger Period** and **Self Trigger Count** accordingly.

Note

- Self trigger period should be greater than the reciprocal of the actual frame rate.
- The device will trigger indefinitely until the execution of the self trigger stop.

4. Click **Execute** in **Self Trigger Start** to let the device perform the trigger operation with configured **Self Trigger Period** and trigger will automatically stop when trigger count reaches configured **Self Trigger Count**.
5. (Optional) Click **Execute** in **Self Trigger Stop** to stop trigger.

Note

You can use the device's trigger switch to start and stop self trigger.

9.8 Code Reading Result Settings

In **Data Processing** module, you can set filter rules for reading codes and other data processing related parameters.

9.8.1 Set Filter Rule

You can set rules to filter unwanted codes to improve the reading efficiency in **Filter Rule**.

Note

The filter rule parameters may differ with different device modes and trigger modes.

When the device mode is **Normal** and **Trigger Mode** is **On**, you can set the following parameters according to actual demands.

Min. Output Time

It sets the min. waiting time before data output. For example, if you set 500 ms as **Min. Output Time**, the code would not be outputted until 500 ms is passed.

Numeral Filter

If this parameter is enabled, the device will only parse and read the numeral contents of the codes, and the non-numeral contents will be filtered out.

Max. Output Length

It sets the max. length of code that can be output.

Code Offset Num

It sets the range of code to be filtered. For example, the code is ABCDEFG, if you set this parameter as 2, the device will output CDEFG at last and filter AB.

Begin with Specific Character for Result

If this parameter is enabled, the device will only read the codes which begin with a specific character. Otherwise, the codes will be filtered out. You can enter the specific character in **Begin with**.

Include Specific Character in Code

If this parameter is enabled, the device will only read the codes which include a specific character. Otherwise, the codes will be filtered out. You can enter the specific character in **Character**.

Exclude Specific Character in Code

If this parameter is enabled, the device will only read the codes which exclude a specific character. Otherwise, the codes will be filtered out. You can enter the specific character in **Character**.

Regular Expression Filter Enable

If this parameter is enabled, the device will only read the codes which contain a specific

regular expression. You can enter the specific regular expression in **Regular Expression Filter Rules**.

Min. Code Length

If the length of a code is shorter (in terms of the number of characters contained in the code) than the configured value, the device will not parse the contents of the code. The valid value is from 1 to 256. For example, if you set the value as 6, the device will not parse the contents of the codes which contain less than 6 characters.

Max. Code Length

If the length of a code is longer ((in terms of the number of characters contained in the code) than the configured value, the device will not parse the contents of the code. The valid value is from 1 to 256. For example, if you set the value as 9, the device will not parse the contents of the codes which contain more than 9 characters.

Read Times Threshold

If the reading results of a code is same for the configured times, the code will be regarded as valid and its reading result will be outputted. Or the code will be regarded as invalid and its reading result will not be outputted.

Reread Filtering Enable

If it is enabled, duplicated code information within the specified quantity and time will be filtered.

Reread Filtered Code Quantity

The device will filter out duplicated codes according to configured code quantity here. For example, if this parameter is 20, then the duplicated code within 20 codes will be filtered.

Reread Filter Time (ms)

The duplicated codes will be filtered out in this configured time.

Reset Reread Filtered Code

Click **Execute** here to reset configured **Reread Filtered Code Quantity** and **Reread Filter Time (ms)**.

9.8.2 Set Result Format

Result format settings allow you to set the format and contents contained in the outputted code information. Result format is related to communication protocol and trigger mode. With different selected communication protocol and trigger mode, you need to set corresponding parameters. Here we use normal device mode and trigger is on as an example to introduce corresponding parameters.

Note

- The supported communication protocols may differ by device models.
- Result format settings are only available if you select **TCP Client**, **TCP Server**, **Serial**, **FTP**, **UDP**, **ModBus**, **USB** and **Bluetooth** as the communication protocol when device mode is

Normal. Result format settings are not available for **Smart SDK**.

- For details about communication protocol, see section **Communication Settings** for details.
-

Result Output via Smart SDK

When the communication protocol is **Smart SDK**, device mode is **Normal** and trigger mode is **On**, you just need to set **NoRead Image Index** in the **Data Processing**.

Note

The configurable parameters may differ if the internal trigger mode is enabled.

NoRead Image Index

It sets the specific image that is outputted when no code information is read. For example, if you set this parameter as 5, and the 5th image will be output.

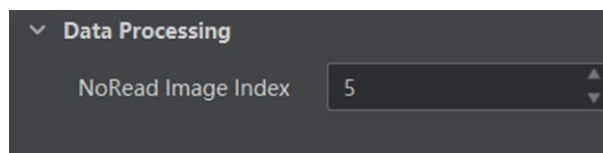

Figure 9-14 Result Output via Smart SDK

Result Output via FTP

If **FTP** is selected as **Communication Protocols**, you need to set following parameters.

Note

The configurable parameters may differ by the trigger mode, and here we take the external trigger mode as an example.

NoRead Image Index

It sets the specific image that is outputted when no code information is read. For example, if you set this parameter as 5, and the 5th image will be output.

Output Retrans Enable

If this parameter is enabled, the data is allowed to retransmit to FTP server, and should set specific value in **Output Retrans Number**.

Note

If data retransmission is still failed after the times allowed for data retransmission is reached, the retransmission will be discarded.

FTP Transmission Conditions

It sets the condition to upload the data outputted by the device to FTP server. **All** refers to

upload the data always. **Read Code** refers to upload the data only when the code is read by the device. **No Read Code** refers to upload the data only when no code is read by the device.

FTP Transmission Result Contain

It selects contents to upload to the FTP server. **Just Result** refers to only upload the content of the code. **Just Picture** refers to only upload the code picture. **Result and Picture** refers to upload both the content of the code and the picture.

FTP Image Format

It sets the format of the picture uploaded to FTP server.

Note

The device currently support JPG format only.

FTP File Default Name

It refers to the default name of the file uploaded to FTP server. You can set it according to actual condition.

FTP File Separator

It refers to the separator that separates file name. You can set it according to actual condition.

FTP File Name Contain Package Number Enable

If this parameter is enabled, the name of the file uploaded to FTP server will contain the package ID.

FTP File Name Contain Barcode Number Enable

If this parameter is enabled, the name of the file uploaded to FTP server will contain the number of the code.

FTP File Name Contain Barcode Info Enable

If this parameter is enabled, the name of the file uploaded to FTP server will contain the name of the package.

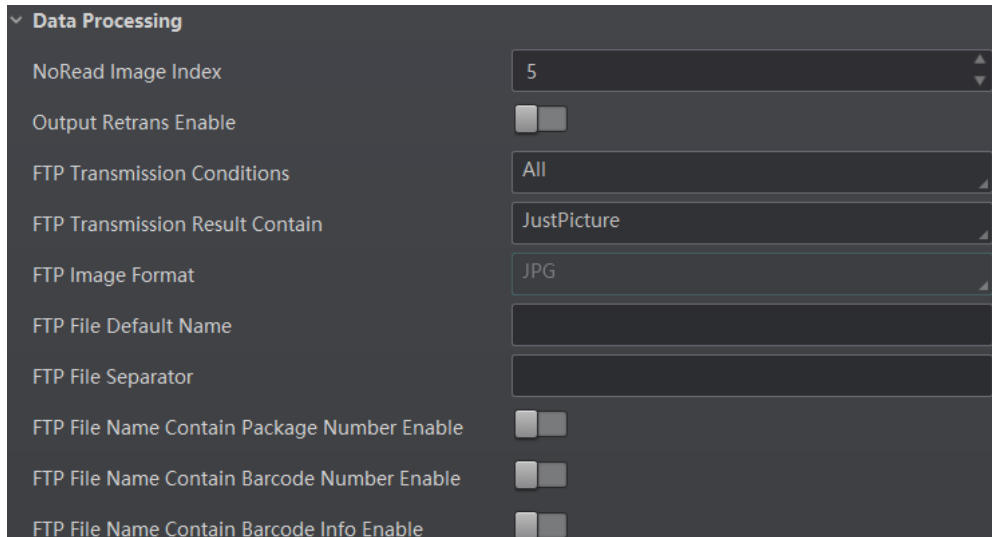

Figure 9-15 Result Output via FTP

Result Output via 2.4G

If **2.4G** is selected as **Communication Protocols**, you need to set following parameters.

NoRead Image Index

It sets the specific image that is outputted when no code information is read. For example, if you set this parameter as 5, and the 5th image will be output.

2.4G Output NoRead Enable

If it is enabled, and the device will output the content you set in **2.4G NoRead Text** when no code is recognized.

2.4G NoRead Text

It is the content that the device will output when no code is recognized.

2.4G Format Output Content

It sets information tag of different outputted contents.

2.4G Format Check

You should click **Execute** in **2.4G Format Check** to check if you entered is right in format, and the check result will be displayed in **2.4G Format Check Result**.

2.4G Format Check Result

It displays the format check result and <success> stands for the check result is successfully.

2.4G Start Text

The contents of the start part of the data outputted. You can set the contents according to actual condition.

2.4G Stop Text

The contents of the end part of the data outputted. You can set the contents according to actual condition.

2.4G Output Barcode Enter Character Enable

If it is enabled, carriage return will be added at the last of a trigger number.

2.4G Output Barcode Newline Character Enable

If it is enabled, a newline will be added at the last of a trigger number.

Result Output via Other Communication Protocols

If **TCP Client**, **TCP Server**, **Serial**, **UDP**, **ModBus**, **USB** or **Bluetooth** is selected as **Communication Protocols**, you need to set following parameters.

Note

- The configurable parameters may differ by the trigger mode, and here we take the external trigger mode as an example.
 - When the communication protocol is **TCP Client**, **TCP Server**, **Serial**, **UDP**, **ModBus**, **USB** or **Bluetooth**, the configurable parameters are similar with slight difference in term of parameter names. Here we take **TCP Client** as **Communication Protocols** as an example, and refer to the actual device you got for details.
-

TCP Output Format Flag Add

It selects what contents you want to output, including code content, code type, angle, trigger start time, code score, etc. You can select multiple contents as desired.

TCP Format Check

You should click **Execute** in **TCP Format Check** to check if you entered is right in format, and the check result will be displayed in **TCP Format Check Result**.

NoRead Image Index

It sets the specific image that is outputted when no code information is read. For example, if you set this parameter as 5, and the 5th image will be output.

TCP Output NoRead Enable

If it is enabled, and the device will output the content you set in **TCP Output NoRead Text** when no code is recognized.

TCP Output Start Text

The contents of the start part of the data outputted. You can set the contents according to actual condition.

TCP Output Stop Text

The contents of the end part of the data outputted. You can set the contents according to actual condition.

TCP Output Barcode Enter Character Enable

If it is enabled, carriage return will be added at the last of a trigger number.

TCP Output Barcode Newline Character Enable

If it is enabled, a newline will be added at the last of a trigger number.

9.9 Communication Settings

The communication protocol is used to transmit and output code reading result and image. The communication protocol is related to the device modes. With various device modes, the device supports different communication protocols and corresponding parameters.

When device mode is **Test** or **Raw**, the device only supports **SmartSDK** protocol and no parameter settings are required. While in **Normal** mode, the device supports **SmartSDK**, **TCP Client**, **Serial**, **FTP**, **TCP Server**, **UDP**, **USB**, **ModBus** and **Bluetooth** communication protocols, and you need to set corresponding parameters.

Note

- The supported communication protocols may differ by device models.
 - The specific parameters of communication protocols may differ by device models.
-

9.9.1 Smart SDK

If **Smart SDK** is selected as the **Communication Protocols**, you can enable **SmartSdk Protocol** to let the device output data via **Smart SDK**.

Encode JPG Flag

If enabled, the device will compress the image data.

Quantity of Jpg

You can enter a number (range: 50 to 99) to determine the compression quality

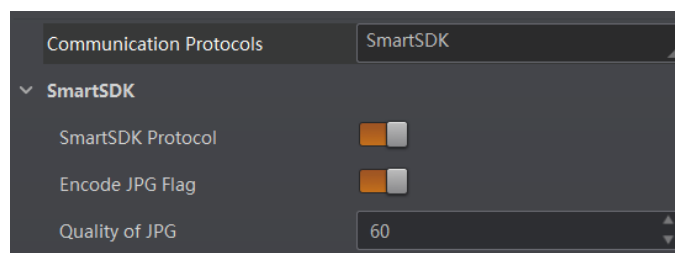

Figure 9-16 Smart SDK

9.9.2 USB

If **USB** is selected as the **Communication Protocols**, you can enable **USB Enable**, set **USB**

Output, USB Baudrate, USB Data Bits, USB Parity, and USB Stop Bits.

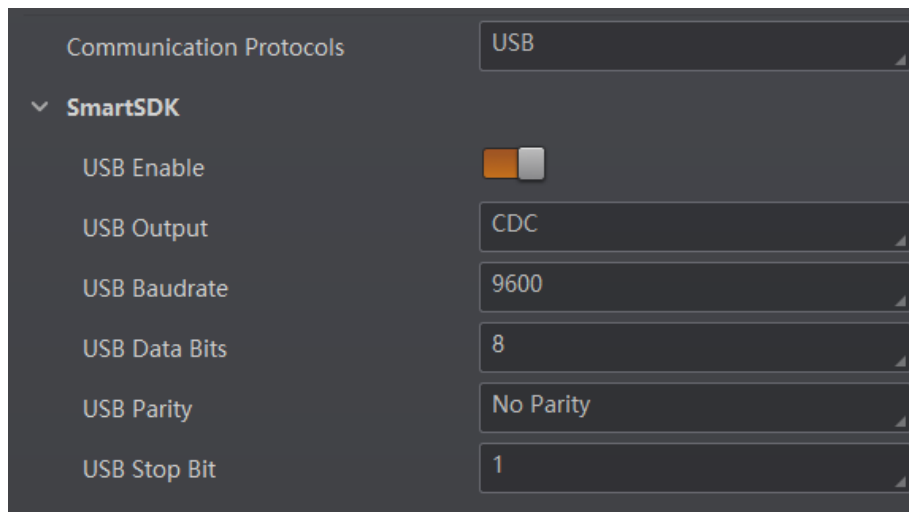

Figure 9-17 USB

Note

USB Baudrate, USB Data Bits, USB Parity, and USB Stop Bits are displayed only when the **USB Output** is **CDC**.

9.9.3 TCP Client

If select **TCP Client** as the **Communication Protocols**, you need to set following parameters. **Output Result Buffer:** If enabled, when the TCP server is abnormal, the device will cache the images. When the server returns to normal, the device will send the cached images to the server. After this parameter being enabled, you can set **Output Result Buffer Number** to determine the number of the images that the device will cache.

You can also enable **TCP Protocol**, enter **TCP Dst Addr** and **TCP Dst Port**.

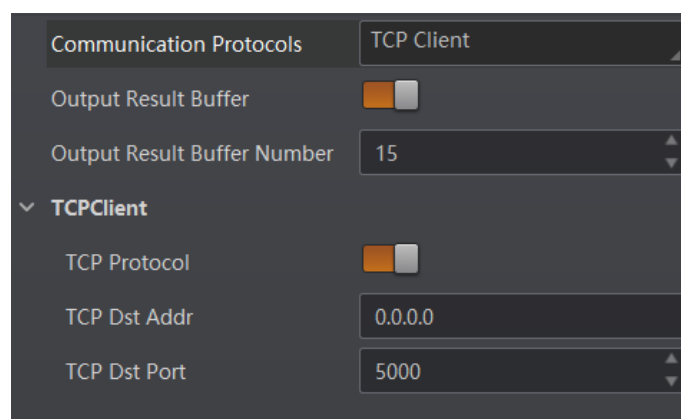

Figure 9-18 TCP Client

9.9.4 Serial

If **Serial** is selected as the **Communication Protocols**, you can enable **Serial Protocol**, enter **Serial Baud Rate**, **Serial Data Bits**, **Serial Parity**, and **Serial Stop Bits**.

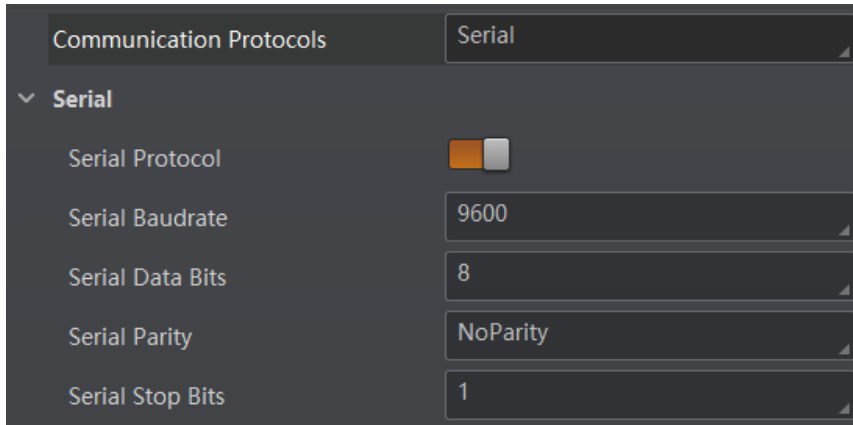

Figure 9-19 Serial

9.9.5 FTP

If select **FTP** as the **Communication Protocols**, you need to set following parameters.

Output Result Buffer: If enabled, when the FTP server is abnormal, the device will cache the images. When the FTP server returns to normal, the device will send the cached images to the server. After this parameter being enabled, you can set **Output Result Buffer Number** to determine the number of the images that the device will cache.

You can also you can enable **FTP Protocol**, enter **FTP Host Addr**,**FTP Host Port**, **FTP User Name**, and **FTP User PWD**.

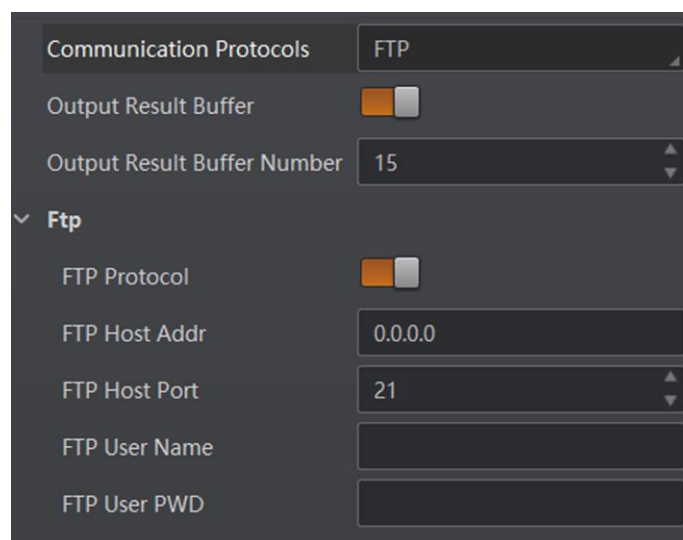

Figure 9-20 FTP

9.9.6 TCP Server

If **TCP Server** is selected as the **Communication Protocols**, you can enable **TCP Server Enable**, and enter **TCP Server Port**.

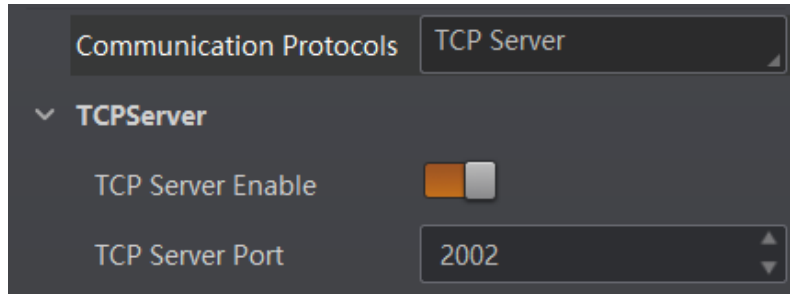

Figure 9-21 TCP Server

9.9.7 UDP

If **UDP** is selected as the **Communication Protocols**, you can enable **UDP Protocol Enable**, and set **UDP Dst IP** and **UDP Dst Port**.

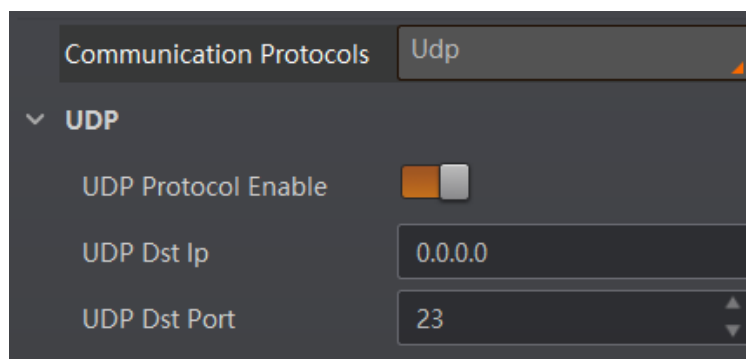

Figure 9-22 UDP

9.9.8 ModBus

If **ModBus** is selected as the **Communication Protocols**, you can enable **ModBus Enable** and set related parameters according to actual demands.

ModBus Mode

It includes server and client, and is server by default.

Note

If client is selected as **ModBus Mode**, you need to set **ModBus Server IP** and **ModBus Server Port**.

ModBus Control Space

It is holding_register by default.

ModBus Control Offset

It refers to the address offset, and is 0 by default.

ModBus Control Size (Word)

It is 1 by default.

ModBus Status Space

It is holding_register by default.

ModBus Status Offset

It is 1 by default.

ModBus Status Size (Word)

It is 1 by default.

ModBus Result Space

It is holding_register by default.

ModBus Result Offset

It is 2 by default.

ModBus Result Size (Word)

It sets max. length of ModBus result. It is 100 by default.

ModBus Result Byte Swap

If it is enabled, the client software will swap ModBus results.

ModBus Result Timeout (s)

It sets the ModBus result timeout, and the unit is s.

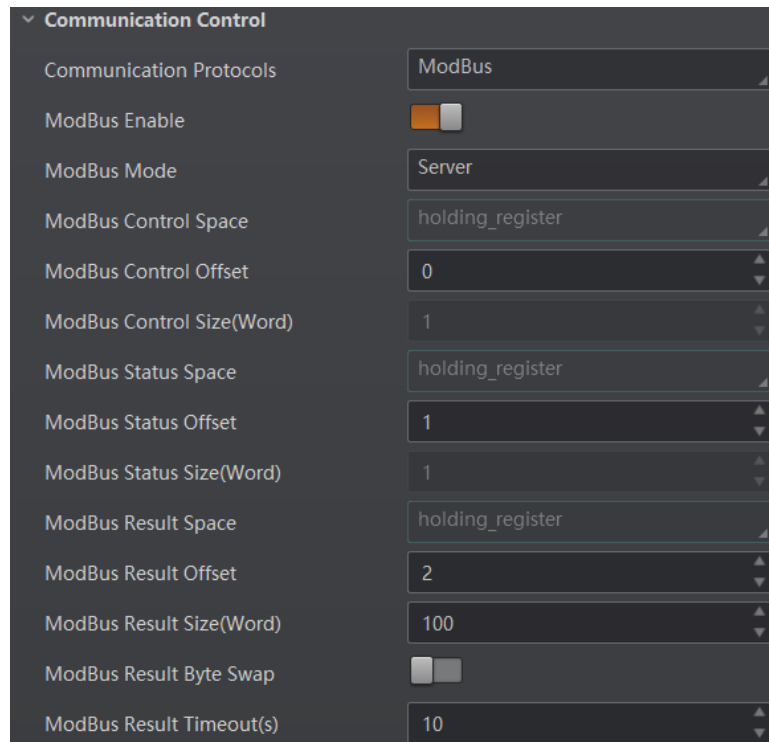

Figure 9-23 ModBus

9.9.9 Bluetooth

If **Bluetooth** is selected as the **Communication Protocols**, the device executes data communication via Bluetooth. You should set following parameters.

- **HID**: The device executes data communication by connecting to mobile phone, PC via Bluetooth if **HID** is selected as **Bluetooth Output Mode**.
- **IDA**: The device executes data communication by connecting to smart base via Bluetooth if **IDA** is selected as **Bluetooth Output Mode**.

Note

- Restarting the device is required when selecting **Bluetooth** as the **Communication Protocols** to execute data communication.
 - The Bluetooth communication protocol may differ by device models and firmware versions. Refer to the device you purchased for actual conditions.
-

9.9.10 Profinet

If you select **Profinet** as the communication protocol, you can configure the following parameters:

- **Profinet Enable**: If enabled, the device will output data via Profinet protocol.
- **Profinet Device Name**: Enter the name of external device, which is used for code reader recognition in Profinet protocol communication.

9.9.11 Ethernet/IP

If you select **EthernetIp** as the communication protocol, you can configure the following parameters:

Ethernet/IP Enable: If enabled, the code reader will output data via Ethernet/IP protocol.

9.9.12 2.4G

If you select **2.4G** as the communication protocol, you can configure the following parameters:

2.4G Enable: If enabled, the code reader will output data via 2.4G protocol.

9.10 User Set Customization

The Configuration Management module allows you to set and manage the user set. A user set is a group of parameter values with all the settings needed to control the device, and you can save, load and switch different user sets.

Note

The device currently supports one user set only (**UserSet1**).

Save Settings

If you have set the device parameters as desired, you can save them into the user set. Go to **Config Management** → **Save Settings**, and click **UserSet1** to save the current device settings.

Note

The system will automatically save the corresponding information to **UserSet1** after you edit parameters by using setting codes.

Load Settings

You can load the user set to restore the device to the saved group of parameter values again if required. Go to **Config Management** → **Load Settings**, and click **Default** or **UserSet1** to load settings.

Note

The **Default** refers to restore the device parameter settings to the factory ones.

Start Settings

The selected user set will be automatically loaded after the device being powered on. For example, if you select **Default**, the device parameter settings will be restored to the factory settings.

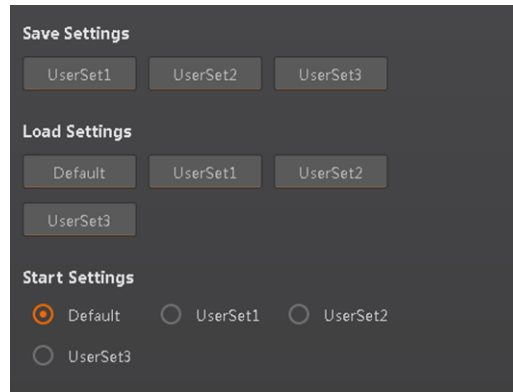

Figure 9-24 User Set Customization



Chapter 10 Device Operation

The device operation section introduces some basic device operations about how to start live view, acquisition and recording, add cross line in the image, split window, view reports, etc.

Note

Connecting the device to the client software is required before device operation.

10.1 Live View

You can view the real-time image in the live view window. Click  in live view window to start live view, or click  to stop.

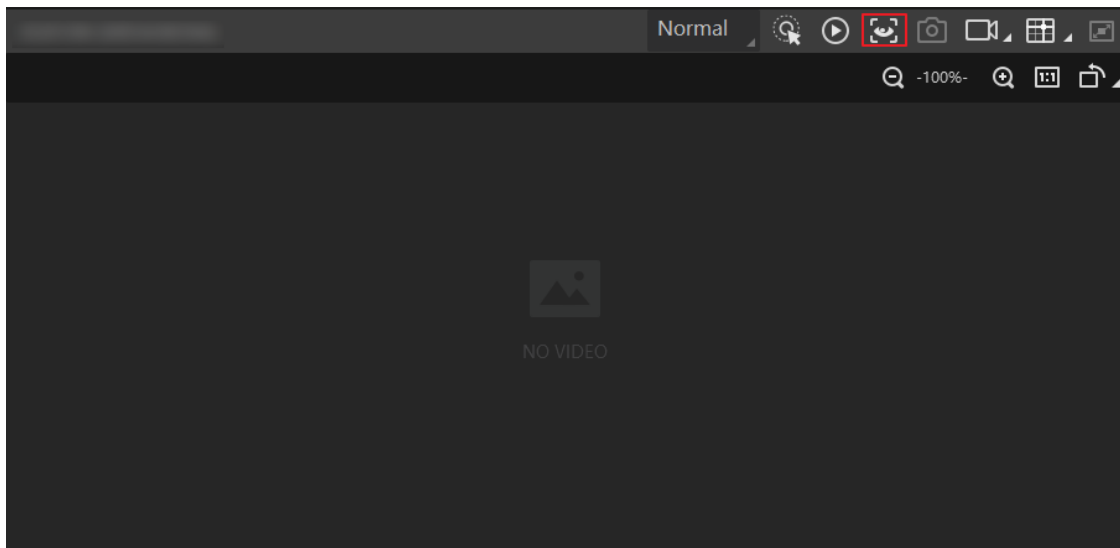



Figure 10-1 Live View

10.2 Enable Acquisition

Enabling acquisition allows the device to acquire the real-time stream. Click  in live view window to start acquisition, or click  to stop. You can also right click the device on the device list, and click **Stop Acquisition** to stop acquiring streams.

Note

Acquisition is still going on if you only stop live view.

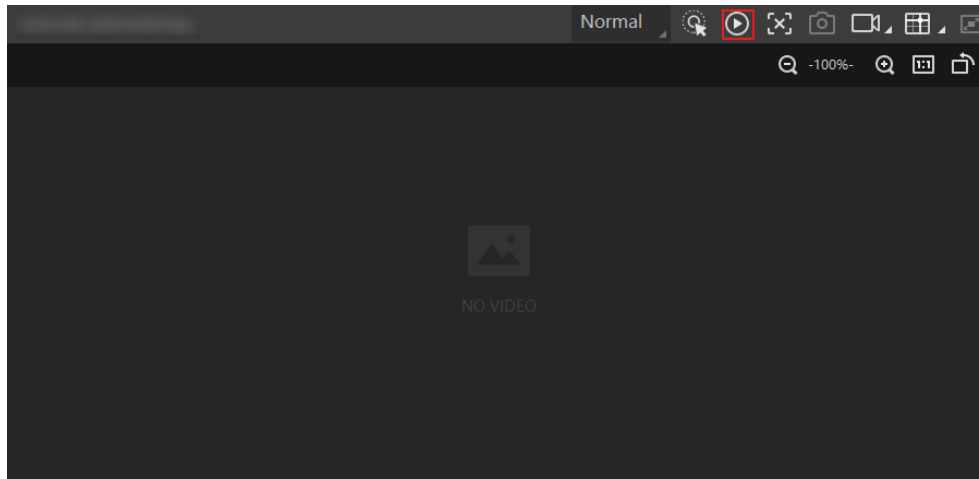

Figure 10-2 Enable Acquisition

10.3 Add Cross Line

During live view, you can add a cross line on the live view image to adjust the position of the object in the view.



Click  in live view window to add cross line, and click  (beside ) to open the editing window to set cross line parameters.







Figure 10-3 Add Cross Line

10.4 Start Recording

During live view, you can record video files and capture images continuously.

Note

Enabling acquisition is required before recording.

Click  in live view window to start recording, and click the icon again to stop. You can also click  (beside ) , and then click  to capture images of the live view continuously.

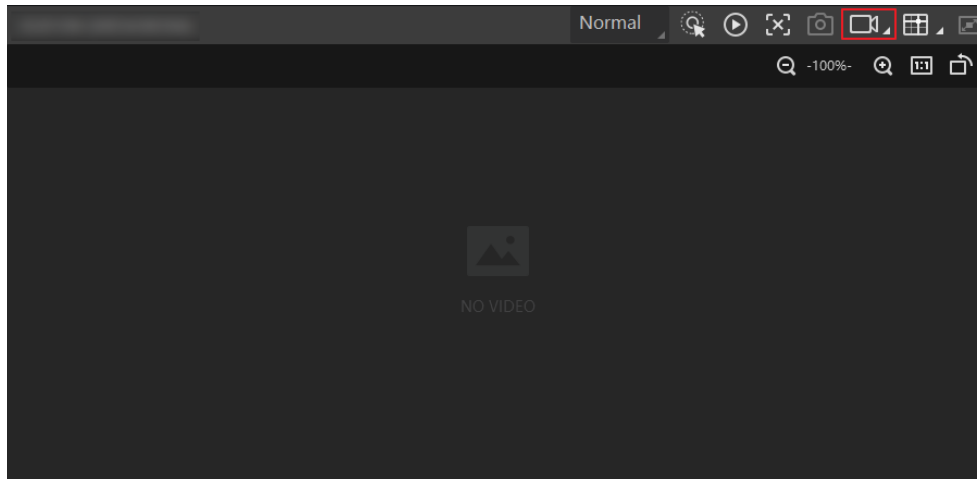



Figure 10-4 Start Recording

10.5 Split Window

The client software supports window division function that allows you to split the window into multiple-window mode to view the live view of multiple devices at the same time. Click  in control toolbar to select window division mode. You can click **Custom** to customize window division as you desired.

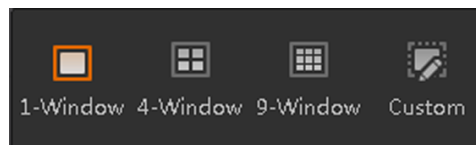



Figure 10-5 Split Window

10.6 View Reports

During acquisition or live view, you can view the reading status of the device. Click  in control toolbar to open the statistics window to view the detailed information. **Read Code Images** refers to the number of the images on which the codes are read by the device. **Unread Code Images** refers to the number of the images on which the codes are not read by the device. **Read Rate** refers to the code reading rate.

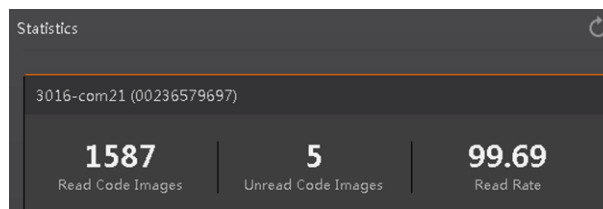

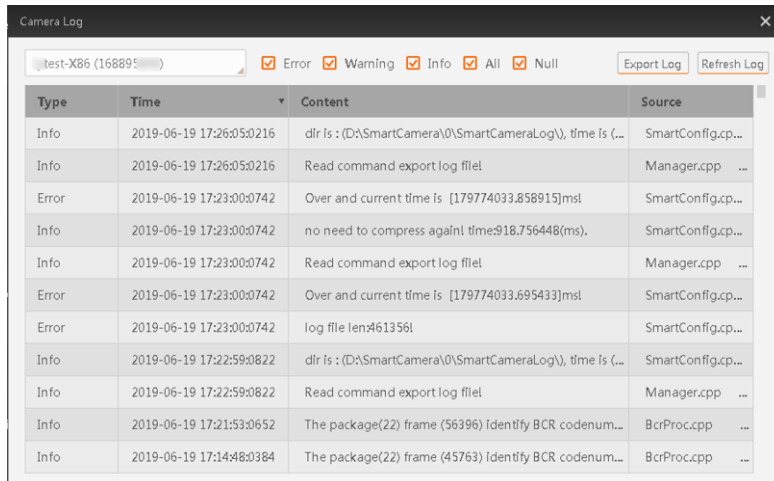

Figure 10-6 View Reports

10.7 View Log

You can view the device logs and export them to the local PC. Click  in control toolbar to open the device log window, and you can view different types of logs, including device errors, warning, and informational log, etc.



Type	Time	Content	Source
Info	2019-06-19 17:26:05:0216	dir is : (D:\SmartCamera\0\SmartCameraLog\), time is (...)	SmartConfig.cp...
Info	2019-06-19 17:26:05:0216	Read command export log file!	Manager.cpp ...
Error	2019-06-19 17:23:00:0742	Over and current time is [179774033.858915]ms!	SmartConfig.cp...
Info	2019-06-19 17:23:00:0742	no need to compress again! time:918.756448(ms).	SmartConfig.cp...
Info	2019-06-19 17:23:00:0742	Read command export log file!	Manager.cpp ...
Error	2019-06-19 17:23:00:0742	Over and current time is [179774033.695433]ms!	SmartConfig.cp...
Error	2019-06-19 17:23:00:0742	log file len:461356!	SmartConfig.cp...
Info	2019-06-19 17:22:59:0822	dir is : (D:\SmartCamera\0\SmartCameraLog\), time is (...)	SmartConfig.cp...
Info	2019-06-19 17:22:59:0822	Read command export log file!	Manager.cpp ...
Info	2019-06-19 17:21:53:0652	The package(22) frame (56396) Identify BCR codenum...	BcrProc.cpp ...
Info	2019-06-19 17:14:48:0384	The package(22) frame (45763) Identify BCR codenum...	BcrProc.cpp ...

Figure 10-7 View Log

10.8 Set Time

After enabling NTP time synchronization, the device will synchronize time according to the configured interval.

Steps

1. Go to **Config Management**, and find **Timing**.
2. Click **Setting** and enable **NTP Enable**.
3. Set parameters according to actual demands.

Note

Configure NTP server settings before using NTP time synchronization function.

4. Click **OK** after settings.

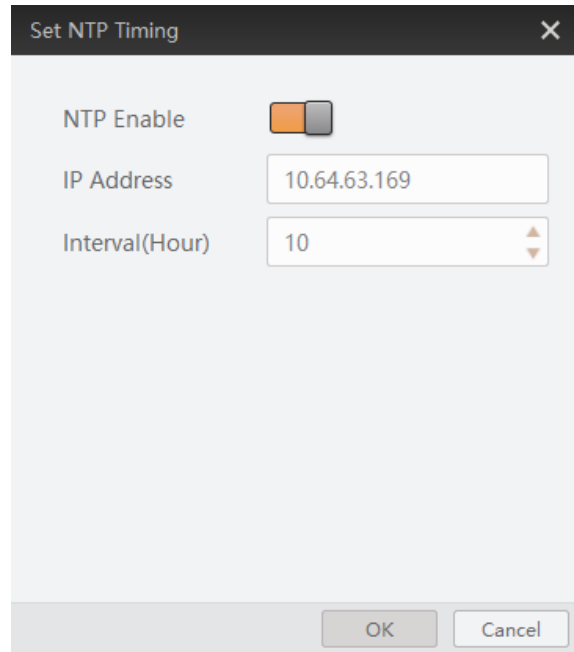

Figure 10-8 Set NTP Timing

10.9 Enable Device Auto Work

This function allows the device to automatically enter the operating status after being powered on.

You can go to **Config Management** → **Device Auto Work Enable**, and enable **Device Auto Work Enable**.

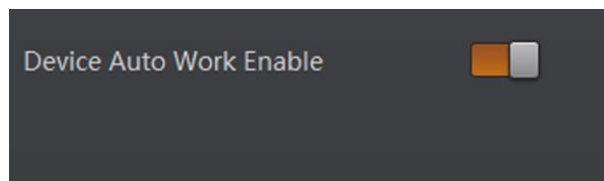

Figure 10-9 Enable Device Auto Work

Chapter 11 Device Maintenance

11.1 Update Firmware

The device supports updating firmware via the client software.

Note

- Disconnect the device with client software.
 - Please use the firmware package of the corresponding device model for upgrading.
 - Do not power off the device or disconnect network during upgrading.
 - The device will reboot automatically after updating the firmware.
-

Select the device to be updated in the device list, right click the device, and click **Firmware Update**. Click  to select update file from local PC, and click **Update** to update firmware.

Note

You can also go to **Tool** → **Firmware Updater** to update firmware.

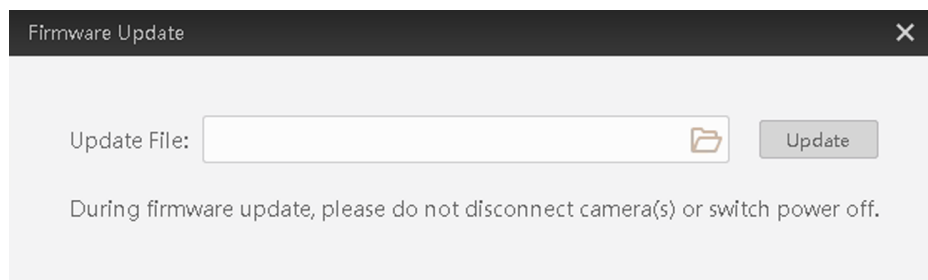

Figure 11-1 Update Firmware

11.2 Recover to Factory Settings

The device supports recovering to factory settings. Go to **Device Control** → **Recover Factory**, and click **Execute** to recover to factory settings.



Figure 11-2 Recover to Factory Settings

11.3 Reboot Device

You can reboot the device via client software in 2 ways. Go to **Config Management**, and click **Restart Device**. Or, you can select the device to be rebooted in the device list, right click the device, and click **Device Reset**.

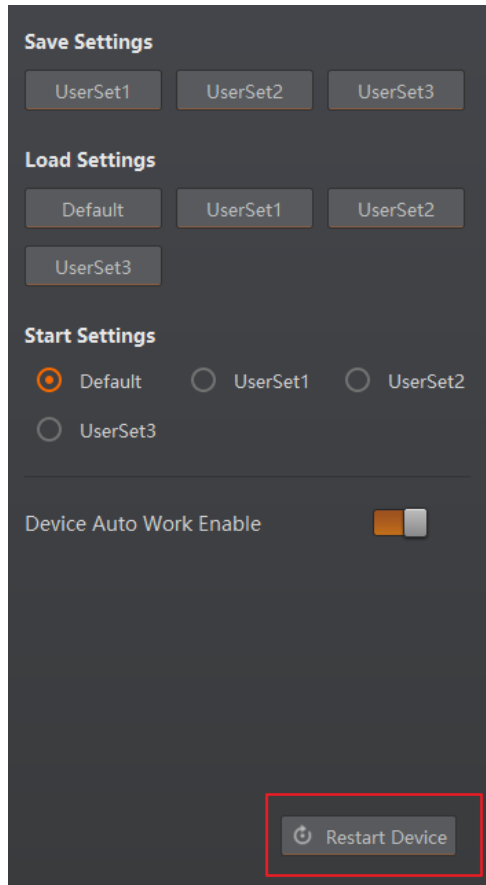

Figure 11-3 Reboot Device

Chapter 12 FAQ (Frequently Asked Question)

12.1 Why there is no buzzer sound and the indicator is unlit after the device is connected?

Reason

- The device's drive is not installed successfully.
- Insufficient battery level of the device.

Solution

- Install the device's drive again.
- Go to **Device Control** to view the device's battery level after it is connected to the smart base.

12.2 Why the device does not read codes after powering on and getting triggered?

Reason

The function of **Device Auto Work Enable** is not enabled.

Solution

Go to **Config Management** → **Device Auto Work Enable**, and enable **Device Auto Work Enable**.

12.3 Why the device does not read codes after connecting to client software and getting triggered?

Reason

Acquisition is not started in the client software.

Solution

Start acquisition and trigger the device again.

12.4 Why there is no buzzer sound after the device reads codes successfully?

Reason

The device's device mode is test mode.

Solution

Set the device mode as normal mode.

12.5 Why configuring setting codes failed though there is buzzer sound?

Reason

The function of setting codes is not activated because **Enable Setting Codes** is not scanned and read.

Solution

Before using other setting codes, you need to scan **Enable Setting Codes** first to activate the function of setting codes.

12.6 Why only a few codes read successfully on the batch code reading mode?

Reason

Improper settings in **Algorithm Settings**.

Solution

Go to **Algorithm Settings** → **Add Barcode**, set the **1D Code Number** and **2D Code Number** according to actual demands.

Appendix A ASCII Table

Note

The USB type device supports the red color character only regarding setting prefix and suffix characters.

Table A-1 ASCII Table

Character	Value	Character	Value	Character	Value	Character	Value
NUL	0	(SPACE)	20	@	40	`	60
SOH	1	!	21	A	41	a	61
STX	2	"	22	B	42	b	62
ETX	3	#	23	C	43	c	63
EOT	4	\$	24	D	44	d	64
ENQ	5	%	25	E	45	e	65
ACK	6	&	26	F	46	f	66
BEL	7	'	27	G	47	g	67
BS	8	(28	H	48	h	68
HT	9)	29	I	49	i	69
LF/NL	0a	*	2a	J	4a	j	6a
VT	0b	+	2b	K	4b	k	6b
FF/NP	0c	,	2c	L	4c	l	6c
CR	0d	-	2d	M	4d	m	6d
SO	0e	.	2e	N	4e	n	6e
SI	0f	/	2f	O	4f	o	6f
DLE	10	0	30	P	50	p	70
DC1/XON	11	1	31	Q	51	q	71
DC2	12	2	32	R	52	r	72
DC3/XOFF	13	3	33	S	53	s	73
DC4	14	4	34	T	54	t	74
NAK	15	5	35	U	55	u	75

Wireless Handheld Code Reader User Manual

Character	Value	Character	Value	Character	Value	Character	Value
SYN	16	6	36	V	56	v	76
ETB	17	7	37	W	57	w	77
CAN	18	8	38	X	58	x	78
EM	19	9	39	Y	59	y	79
SUB	1A	:	3A	Z	5A	z	7A
ESC	1B	;	3B	[5B	{	7B
FS	1C	<	3C	\	5C		7C
GS	1D	=	3D]	5D	}	7D
RS	1E	>	3E	^	5E	~	7E
US	1F	?	3F	-	5F	DEL	7F



HIKROBOT

SHAPE OUR FUTURE INTELLIGENTLY

Hangzhou Hikrobot Technology Co.,Ltd.

E-mail: global.support@hikrobotics.com

Website: <https://en.hikrobotics.com/>

UD36123B