

# CGE Gripper

## Short Manual

### Content

|  |    |
|--|----|
| Revisions.....   | 1  |
| 1 Specifications.....                                    | 2  |
| 1.1 Indicator.....                                       | 2  |
| 1.2 Pinout Description.....                              | 3  |
| 2 Modbus-RTU Control.....                                | 4  |
| 2.1 Debugging software description.....                  | 4  |
| 2.1.1 Installation and wiring of debugging software..... | 4  |
| 2.1.2 Debugging software instructions.....               | 5  |
| 2.2 Default Communication Parameters.....                | 8  |
| 2.3 Modbus-RTU Description.....                          | 9  |
| 2.3.1 RTU Framing.....                                   | 9  |
| 2.3.2 Supported Modbus Function Code.....                | 9  |
| 2.3.3 Register Mapping.....                              | 10 |
| 2.3.4 Register Description.....                          | 11 |
| 2.3.4.1 Initialization.....                              | 11 |
| 2.3.4.2 Force.....                                       | 12 |
| 2.3.4.3 Position.....                                    | 13 |
| 2.3.4.4 Speed.....                                       | 13 |
| 2.3.4.5 Initialization State.....                        | 14 |
| 2.3.4.6 Gripper State.....                               | 14 |
| 2.3.4.7 Current Position.....                            | 15 |
| 2.3.4.8 Save Parameter.....                              | 15 |
| 2.3.4.9 Initialization Direction.....                    | 16 |
| 2.3.4.10 Slave Address.....                              | 16 |
| 2.3.4.11 Baud Rate.....                                  | 17 |
| 2.3.4.12 Stop Bits.....                                  | 17 |
| 2.3.4.13 Parity.....                                     | 18 |
| 2.3.4.14 Test I/O Parameters.....                        | 18 |
| 2.3.4.15 I/O Mode Switch.....                            | 19 |
| 2.3.4.16 I/O Parameter Configuration.....                | 20 |
| 3 I/O Control.....                                       | 21 |
| 3.1 I/O Configuration.....                               | 21 |
| 3.2 IO use.....  | 23 |

## Revisions

| Date     | Version | Revised content  |
|----------|---------|--|
| 20200426 | V1.0    | First edition, write wiring instructions and command instructions  |
| 20200904 | V2.0    | Change some instructions , Update the description of IO mode   |
| 20210401 | V2.1    | Normal update  |
| 20210727 | V2.2    | Modify the high resistance description to disconnect, add communication format and detailed IO, batch update, line sequence modification |
| 20211008 | V2.3    | Delete the data that has nothing to do with the operation part, and re-typesetting   |

# 1 Specifications

CGE series are three finger cooperative gripper. The number represents the maximum clamping force of a single fingertip. The gripper are equipped with three fingertips, which are evenly distributed in a circle. The main structure of the gripper is a smooth rectangular structure. It is equipped with an 8-core communication interface, as shown in Figure 1.1. It has the following characteristics:

**Controllable force/position/speed:** The gripper can program and adjust the grip position, grip force and speed.

**Multiple communication modes:** The gripper supports Modbus RTU protocol and IO mode control. Other communication protocols such as Ethernet and ETHERNET can be transferred through protocol converter.

**Gripping Detection:** The combination of force control and position control is adopted in the gripping process.

**Gripping feedback:** The state of the gripper can be read by programming, and can also be judged according to the indicator of the gripper.

**Fingertips can be customized:** Fingertips can be replaced according to situation, which is suitable for precision machining, parts assembly, and other fields.

## 1.1 Indicator

The gripper can feed back the state of the gripper in real time. In addition to the command reading, it can also be judged on the color of the indicator:

### Color description of indicator light

- **Uninitialized state:** Red light blinks, other lights are off.
- **Initialized State:** the blue light is always on, indicating that it is in the operable state.
- **Received command state:** the red light blink once quickly (because the blue light is always on at this time, the gripper indicator light will look like a purple light).
- **Object Caught state:** green light is always on, other lights are off.
- **Object dropped state:** green light blinking.

## 1.2 Pinout Description

The line sequence definition on the gripper body is shown in Figure 1.1(a) and 1.1(b)

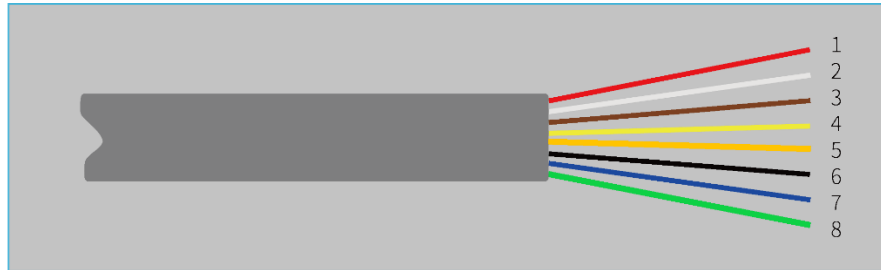

| Wire Number | The blue Wire mark corresponds to the outgoing color | Description | Explanation                       |
|-------------|--|-------------|-----------------------------------|
| 1           | Red  | 24V         | Power supply DC 24V positive      |
| 2           | White  | INPUT1      | IO mode digital input 1           |
| 3           | Brown  | INPUT2      | IO mode digital input 2           |
| 4           | Orange   | OUTPUT1     | IO mode digital output 1          |
| 5           | Yellow   | OUTPUT2     | IO mode digital output 2          |
| 6           | Black  | GND         | Power supply DC GND negative      |
| 7           | Blue   | 485_B       | Communication line negative, T/R- |
| 8           | Green  | 485_A       | Communication line positive, T/R+ |

Figure 1.1 (a) The blue line marked diagram

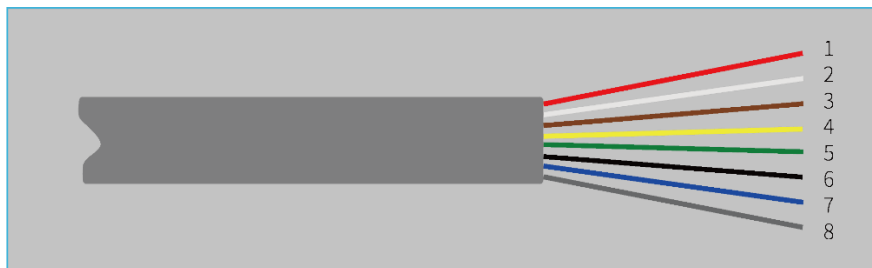

| Wire number | The yellow Wire mark corresponds to the outgoing color | Description | Explanation                       |
|-------------|--|-------------|-----------------------------------|
| 1           | Red  | 24V         | Power supply DC 24V positive      |
| 2           | White  | INPUT1      | IO mode digital input 1           |
| 3           | Brown  | INPUT2      | IO mode digital input 2           |
| 4           | Yellow   | OUTPUT1     | IO mode digital output 1          |
| 5           | Green  | OUTPUT2     | IO mode digital output 2          |
| 6           | Black  | 485_A       | Communication line positive, T/R+ |
| 7           | Blue   | 485_B       | Communication line positive, T/R- |
| 8           | Grey/Pink  | GND         | Power supply DC GND negative      |

Figure 1.1 (b) The yellow line marked diagram

**ote: Please distinguish the wire sequence according to the wire mark. If the wire mark is lost, dropped, or forgotten, please contact our staff to cooperate in determining the wire sequence. If you do not contact our staff, the clamping jaws will be damaged due to the wrong wiring sequence, and you will be responsible for the consequences.**

## 2 Modbus-RTU Control

### 2.1 Debugging software description

The debugging software is specially used to control the gripper and set debugging parameters on the computer. Because there is no RS485 interface in the computer, the USB to 485 module is needed to convert the interface to USB interface, which is convenient for the debugging and control of the gripper in the computer.

#### 2.1.1 Installation and wiring of debugging software

Connecting by debugging software is essentially controlled by RS485 interface. The specific connection needs to be connected to the 24 V, GND, 485\_ A(T/R+,485+) , 485\_ B (T / R -, 485 -) 4 wires in total. The power supply is a 24 V DC regulated power supply. Plug the USB port of the module into the USB port of the computer. The wiring definitions of different series are different. Please connect according to the instruction of specific clamping claw, as shown below:

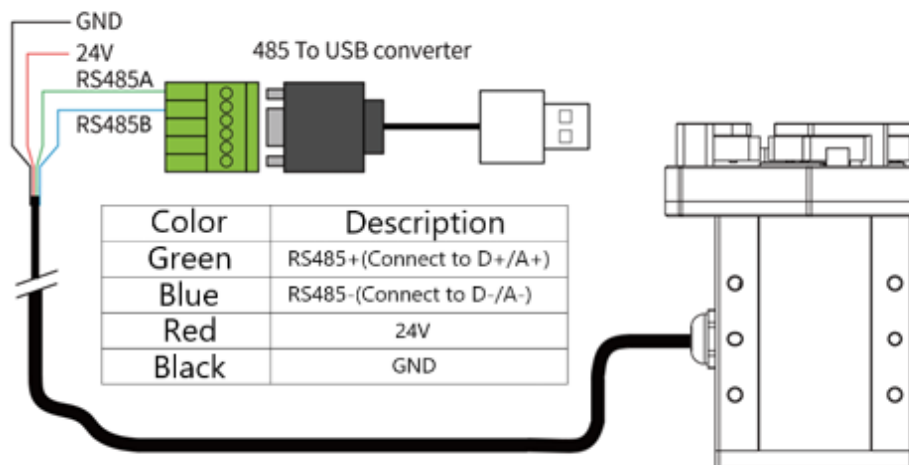

Figure 2.1 RS485 Connection

#### Wiring instructions

- ① : when the device (computer) has RS485 interface, the communication can be directly connected to RS485\_A and RS485\_B communication lines without transferring to 485 module through USB
- ② : in this way, other serial port debugging software (such as MODBUS poll) can be used for debugging

Software can be downloaded on the official website. Software and driver are integrated in the process of software installation, and both are installed together. It is recommended to check the create shortcut during installation.

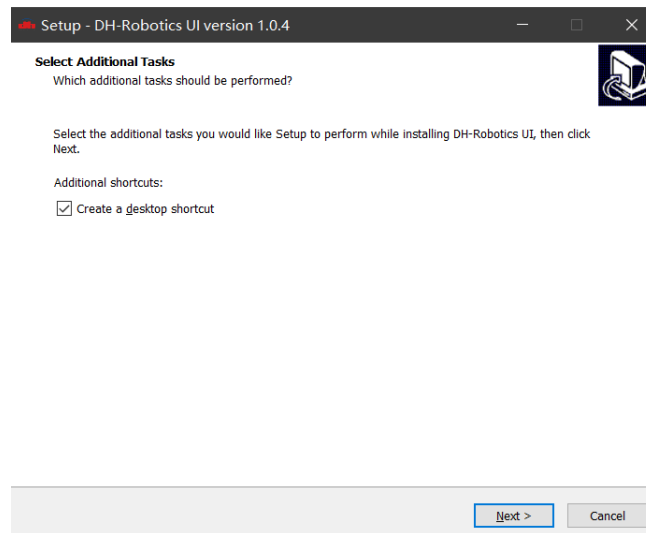

Figure 2.2 (a) installation interface 1

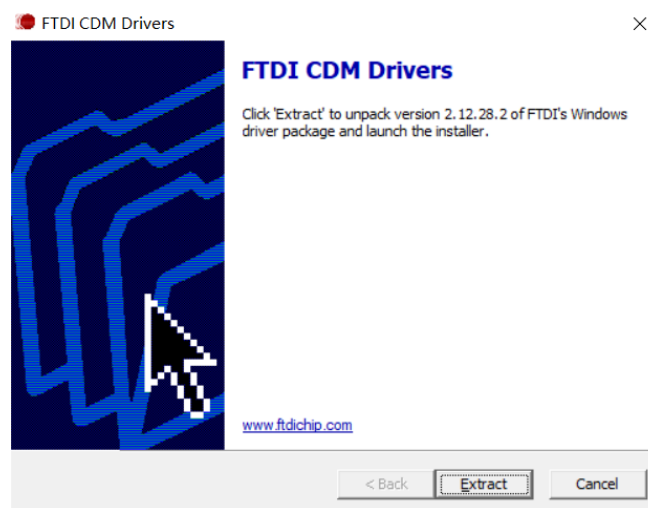

Figure 2.2 (b) driver installation interface

## 2.1.2 Debugging software instructions

Before use, it is necessary to connect the corresponding wiring according to the instructions (see [2.1.1](#) Installation and wiring of debugging software).

Open the software, the software will automatically identify the serial port, baud rate, ID number and other information of the gripper for automatic connection. As shown in the figure below:

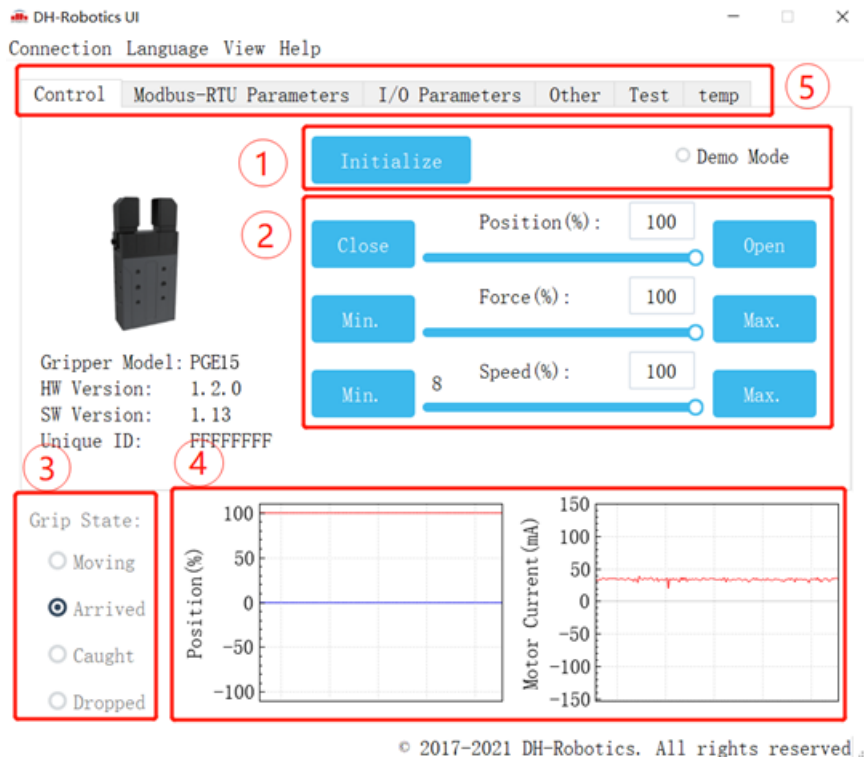

Figure 2.3 main control interface

The specific interface description is as follows:

#### Interface description

- ① **Initialization and demonstration mode:** the gripper needs to be initialized before operation to calibrate the zero point. The demonstration mode is a cyclic program.
- ② **Control interface:** it can control the position, force and speed of the gripper.
- ③ **Clamping status:** real time display of clamping status of clamping claw.
- ④ **Position current real time graph:** real time display position and current. The current represents the current of the internal motor, not the current actually consumed by the gripper. The current real-time graph can reflect the stability of clamping force.
- ⑤ **Parameter setting:** the configuration parameters of Modbus RTU, such as baud rate and check bit, can be configured; IO mode is to configure the parameters related to IO mode;

The gripper body uses Modbus RTU for communication, and can read and write data into the register. The data can be read and written at the view register. The data includes control, feedback, user parameters and I/O parameters as shown in the following figure:

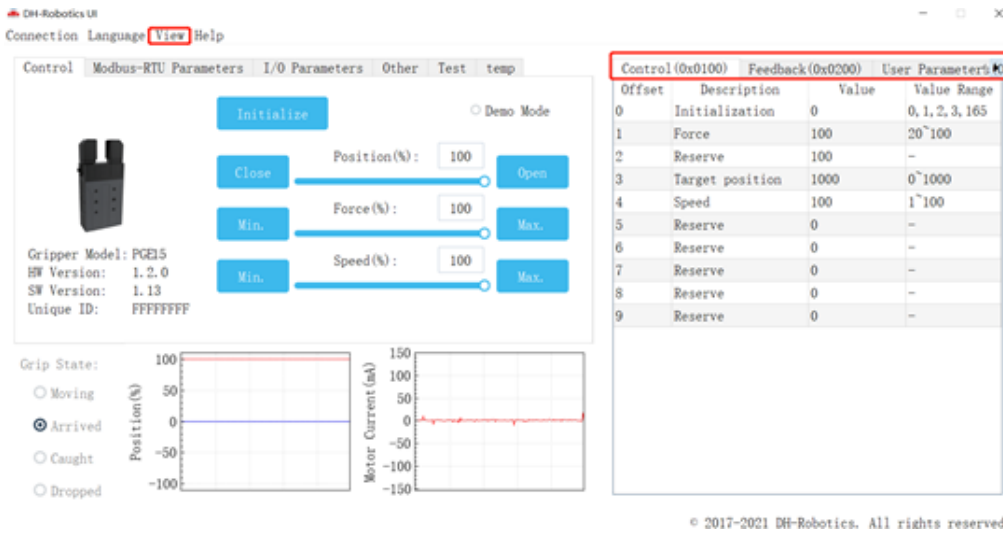

Figure 2.4 View

If there are multiple 485 devices, sometimes the baud rate and ID number of the gripper need to be modified, the parameters can be modified in Modbus RTU parameters

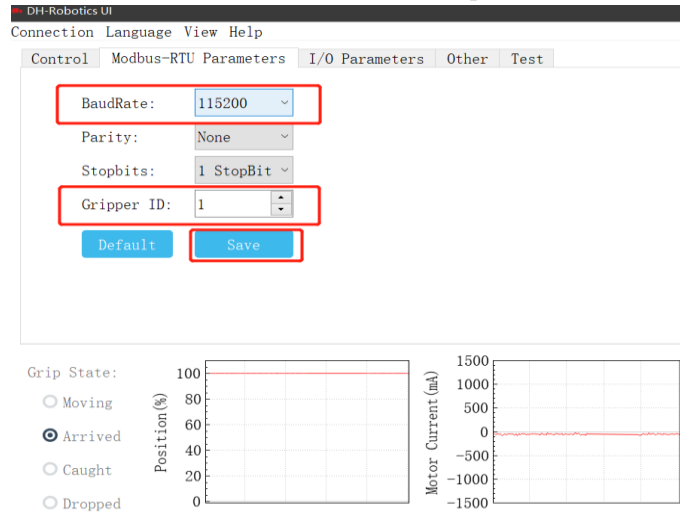

Figure 2.5 Modbus RTU parameters

You can set and configure the gripper I / O parameters in [I / O parameters]. After modifying the parameters, please click Save button to save. The following figure shows the operation of opening IO mode:



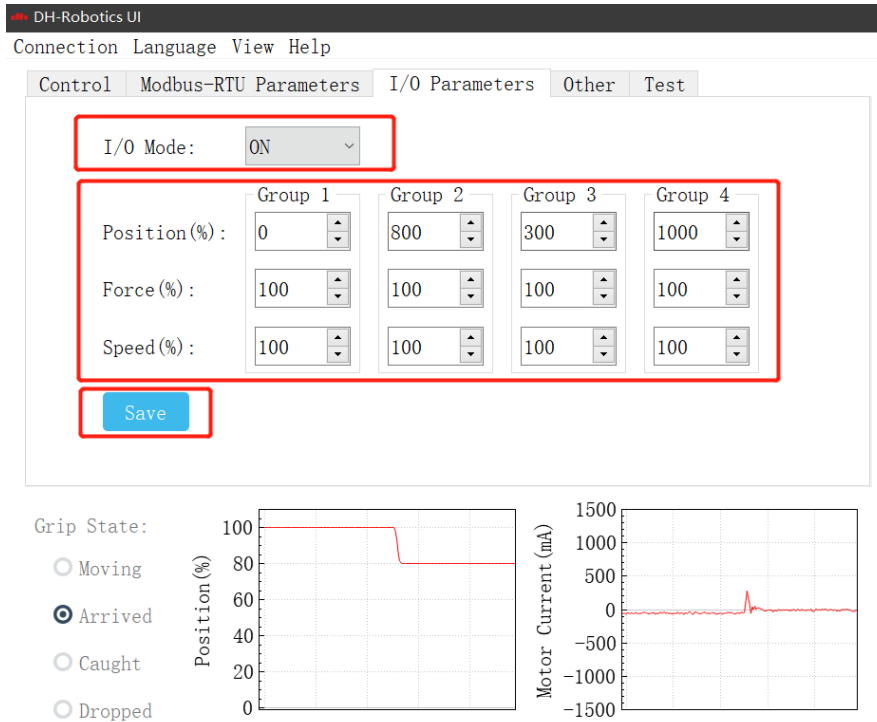

Figure 2.6 Modbus RTU parameters

The steps of switching IO are as follows:

#### Steps to switch IO mode

- ① **Open IO mode:** open IO mode first.
- ② **Configure four groups of IO parameters:** set the four groups of parameters of gripper, including position, force and speed.
- ③ **Save:** click the Save button to write the parameters to the internal register of flash, and restart to control.
- ④ **Restart:** after the restart, the switch to IO mode is successful. You can control the gripper according to the input signal, and the running status will be fed back through output.

## 2.2 Default Communication Parameters

Slave Address : 1  
 Baud Rate : 115200  
 Data Bits : 8 bits  
 Stop Bits : 1 stop bit  
 Parity : None

## 2.3 Modbus-RTU Description

### 2.3.1 RTU Framing

This gripper uses the standard Modbus-RTU protocol.

In RTU mode, the first field is the device address. The allowable characters transmitted for all fields are hexadecimal 0 ... 9, A ... F. Networked devices monitor the network bus continuously, including during the silent intervals. When the first field (the address field) is received, each device decodes it to find out if it is the addressed device.

A typical message frame is shown in Table 2.1.

Table 2.1 RTU Framing (Function Code:0x06)

| Slave Address | Function | Register address | Register data | CRC   |
|---------------|----------|------------------|---------------|-------|
| 01            | 06       | 01 00            | 00 01         | 49 F6 |

**Slave Address:** The Slave address of the gripper. The default is 1, you can also modify it through write different value to Slave Address register.

**Function:** The Function Code field tells the addressed slave what function to perform. Includes read or write registers function.

**Register address:** Specifies which registers reference to be written.

**Register data:** Specifies which value to be written. Each register (word - 16 bits) of the Modbus RTU protocol is composed of 2 bytes (8 bits) from the Gripper.

**CRC:** the CRC error-checking field contains a 16-bit value implemented as two eight-bit bytes. The CRC field is appended to the message as the last field in the frame. The low-order byte of the field is appended first, followed by the high-order byte. The CRC high-order byte is the last byte to be sent in the message.

### 2.3.2 Supported Modbus Function Code

This gripper uses MODBUS- RTU. The following function codes are currently supported:

03 (HEX): Read Holding Registers

04 (HEX): Read Multiple Registers

06 (HEX): Write Single Register

10 (HEX): Write Multiple Registers

### 2.3.3 Register Mapping

The gripper's Modbus-RTU registers consist of two types of registers: **the basic control registers** and **the configuration registers**.

**Basic control registers:** initialization, force setting, reference position, speed, and some states.

**Configuration registers:** gripper's parameter configuration. Includes Modbus communication parameters and I/O parameters.

Table 2.2 Basic Control register map

| Function             | address<br>(hexadecimal) | Description                         | Write   | Read   |
|----------------------|--------------------------|-------------------------------------|---|--|
| Initialization       | 256<br>(0x0100)          | Initialize the gripper              | 0x01: initialization;<br>0xA5: Fully initialization | Current setting  |
| Force                | 257<br>(0x0101)          | Gripper's force                     | 20-100 (%)  | Closing-force currently set  |
| Position             | 259<br>(0x0103)          | Position                            | 0-1000 (‰)  | Reference position currently set   |
| Speed                | 260<br>(0x0104)          | Speed                               | 1-100 (%)   | Speed currently set  |
| Initialization state | 512<br>(0x0200)          | Initialization state of the gripper | Read Only   | 0: Not initialized; 1: Initialized   |
| Gripper state        | 513<br>(0x0201)          | Gripper state                       | Read Only   | 0: In motion;<br>1: Reach position;<br>2 Object caught;<br>3: Object dropped |
| Position             | 514<br>(0x0202)          | gripper position                    | Read Only   | Current real-time position   |

Table 2.3 Configuration register map

| Function                    | High byte | Low bytes | Description                        | Write  | Read            |
|-----------------------------|-----------|-----------|------------------------------------|--|-----------------|
| Save Parameter              | 0x03      | 0x00      | Save all the parameters            | 0: default, 1: Write all parameters to save                  | 0               |
| Initialization direction    |           | 0x01      | Configure initialization direction | 0: Open, 1:Close (default: 0)                                | Current setting |
| Slave Address               |           | 0x02      | Configure gripper Modbus address   | 0-255 (default: 1)   | Current setting |
| Baud Rate                   |           | 0x03      | Configure gripper Modbus Baud rate | 0-5: 115200, 57600, 38400, 19200, 9600, 4800 (default :0)    | Current setting |
| Stop Bits                   |           | 0x04      | Configure gripper Modbus stop bits | 0: 1 stop bit; 1: 2 stop bits (default: 0)                   | Current setting |
| Parity                      |           | 0x05      | Configure gripper Modbus Parity    | 0: None parity; 1: Odd parity; 2: Even parity (default: 0)   | Current setting |
| I/O Parameters Test         | 0x04      | 0x00      | Test I/O parameters                | 1; 2; 3; 4   | Current setting |
| I/O Mode Switch             |           | 0x02      | I/O control switch                 | 0: OFF, 1: ON  | Current setting |
| I/O Parameter Configuration |           | 0x05-0x10 | Four groups of I/O parameters      | position 1, force 1, speed 1 to position 4, force 4, speed 4 | Current setting |

## 2.3.4 Register Description

### 2.3.4.1 Initialization

This register is used to initialize the gripper.

Write: If write 1 (0x01 hex) to this register, the gripper will be initialized (fingers move to the minimal or maximum position. The initialization direction depends on the value of initialization direction register). If write 165 (0xA5 hex) to this register will fully initialize the gripper( find the minimal and maximum position).

Read: if gripper need to be initialized or have initialized, this register value is 0; and if gripper is in initializing process, this register value is 1.

The register address is 0x0100. The description of this register is shown in Table 2.4.

Table 2.4 Initialization

| Function       | Address | Description            | Write                                       | Read            |
|----------------|---------|------------------------|---|-----------------|
| Initialization | 0x0100  | Initialize the gripper | 0x01: initialize;<br>0xA5: Fully initialize | Current setting |

**The gripper needs to be initialized before control.**

The sample command is as follows:

Initialize (write):

Send: 01 06 01 00 01 49 F6

Receive: 01 06 01 00 01 49 F6

Reinitialize(write):

Send:01 06 01 00 00 A5 48 4D

Receive: 01 06 01 00 00 A5 48 4D

### 2.3.4.2 Force

This register is used to set Force. It defines the current for the Gripper. If the current limit is exceeded, the fingers stop and trigger an object detection.

The address is 0x0101. The description of this register is shown in Table 2.5.

Table 2.5 Force

| Function | Address | Description     | Write      | Read                |
|----------|---------|-----------------|------------|---------------------|
| Force    | 0x0101  | Gripper's force | 20-100 (%) | Force currently set |

The force value range is 20-100%, the corresponding value is 00 14–00 64(Hexadecimal).

Example:

Set 30% force (write):

Send: 01 06 01 01 1E 59 FE

Return: 01 06 01 01 1E 59 FE

Read the force currently set (read):

Send: 01 03 01 01 00 01 D4 36

Return: 01 03 02 xx xx crc1 crc2

### 2.3.4.3 Position

This register is used to set the reference position of gripper's fingers, then the fingers will move to the position immediately.

The address is 0x0103. The description of this register is shown in Table 2.6.

Table 2.6 Position

| Function | Address | Description        | Write      | Read                             |
|----------|---------|--------------------|------------|----------------------------------|
| Position | 0x0103  | Reference Position | 0-1000 (‰) | Reference position currently set |

The reference position value range is 0-1000 (‰), the corresponding value is 00 00 – 03 E8(Hexadecimal).

Example:

Set 500‰ position (write):

Send: 01 06 01 03 01 F4 78 21

Return: 01 06 01 03 01 F4 78 21

Read the reference position currently set(read):

Send: 01 03 01 03 00 01 75 F6

Return: 01 03 02 xx xx crc1 crc2

### 2.3.4.4 Speed

This register is used to set the Gripper closing and opening speed.

The address is 0x0102. The description of this register is shown in Table 2.7.

Table 2.7 Speed Instructions

| Function | Address | Description | Write     | Read                |
|----------|---------|-------------|-----------|---------------------|
| Speed    | 0x0104  | Speed       | 1-100 (%) | Speed currently set |

The speed value range is 1-100 , The corresponding value is 00 01 – 00 64(Hexadecimal).

Example:

Set 50% speed (write):

Send: 01 06 01 04 00 32 48 22

Return: 01 06 01 04 00 32 48 22

Read the current speed (read):

Send: 01 03 01 04 00 01 C4 37

Return: 01 03 02 xx xx crc1 crc2

### 2.3.4.5 Initialization State

This register is used to store current initialization state of gripper, you can get the initialization state by reading this register.

The address is 0x0200. The description of this register is shown in Table 2.8.

Table 2.8 Initialization State

| Function             | Address | Description                         | Write     | Read  |
|----------------------|---------|-------------------------------------|-----------|---|
| Initialization State | 0x0200  | Initialization state of the gripper | Read Only | 0: Not initialized; 1: Initialized<br>2: Initializing |

Example:

Read initialization state (read):

Send: 01 03 02 00 00 01 85 B2

Return: 01 03 02 00 00 B8 44

### 2.3.4.6 Gripper State

This register is used to store the Gripper state, you can get the state of gripper by reading this register. And the address is 0x0201. The description of this register is shown in Table 2.9.

Table 2.9 Gripper State

| Function      | Address | Description       | Write     | Read   |
|---------------|---------|-------------------|-----------|--|
| Gripper State | 0x0201  | the gripper state | Read Only | 0: In motion;<br>1: Reached position; 2: Object caught;<br>3: Object dropped |

#### States Description

Different values indicate different states of the gripper. The descriptions of states are as follows:

- 00: Fingers are in motion .
- 01: Fingers are at reference position. No object detected or object has been dropped.
- 02: Fingers have stopped due to an object detection.
- 03: Fingers are at reference position due to object has been dropped after the gripper caught object.

Example:

Read gripper state (read):

Send: 01 03 02 01 00 01 D4 72

Return: 01 03 02 00 02 39 85(02: object caught)

### 2.3.4.7 Current Position

This register is used to store the **actual position** of the Gripper.

The address is 0x0202. The description of this register is shown in Table 2.10.

Table 2.10 Current Position

| Function         | Address | Description                    | Write     | Read                    |
|------------------|---------|--------------------------------|-----------|-------------------------|
| Current Position | 0x0202  | Gripper <b>actual position</b> | Read Only | Current actual position |

Example:

Read actual position (read):

Send: 01 03 02 02 00 01 24 72

Return: 01 03 02 xx xx crc1 crc2

### 2.3.4.8 Save Parameter

This register is used to Save Parameter.

Write 1 to this register to save all parameter, If you modified the I/O or communication parameters.

The address is 0x0300. The description of this register is shown in Table 2.11.

Table 2.11 Save Parameter

| Function       | Address | Description                    | Write                                 | Read |
|----------------|---------|--------------------------------|---------------------------------------|------|
| Save Parameter | 0x0300  | Save register's value to Flash | 0: default,<br>1: Save all parameters | 0    |

Example:

Save Parameter (Write):

Send: 01 06 03 00 00 01 48 4E

Return: 01 06 03 00 00 01 48 4E

#### NOTE

- The Saving process will take 1-2 seconds, and the gripper won't response to other command during this process. The gripper will response this command after saving process finished.



### 2.3.4.9 Initialization Direction

This register is used to set Initialization Direction of gripper.

The address is 0x0301. The description of this register is shown in Table 2.12.

Table 2.12 Baud Rate

| Function  | Address | Description                        | Write                         | Read            |
|-----------|---------|------------------------------------|-------------------------------|-----------------|
| Baud Rate | 0x0301  | Configure initialization direction | 0: Open, 1:Close (default: 0) | Current setting |

The value of this register is 0 by default.

If the register value is 0, when you send the initialization command, the gripper finger will open and find the maximum position.

If the register value is 1, when you send the initialization command, the gripper finger will close and find the minimal position.

Example:

Write 0 to initialization direction register:

Send: 01 06 03 01 00 00 D8 4E

Return: 01 06 03 01 00 00 D8 4E

### 2.3.4.10 Slave Address

This register is used to set Slave Address of gripper.

The address is 0x0302. The description of this register is shown in Table 2.13.

Table 2.13 Slave Address

| Function      | Address | Description                     | Write              | Read            |
|---------------|---------|---------------------------------|--------------------|-----------------|
| Slave Address | 0x0302  | Configure gripper Slave Address | 0-255 (default: 1) | Current setting |

The value of this register is 1 by default.

Example:

Set the Slave Address to 1 (write):

Send: 01 06 03 02 00 01 E9 8E

Return: 01 06 03 02 00 01 E9 8E

#### NOTE

- Please make sure that no other networked device has the same slave address as the gripper.

### 2.3.4.11 Baud Rate

This register is used to set Baud Rate of gripper.

The address is 0x0303. The description of this register is shown in Table 2.14.

Table 2.14 Baud Rate

| Function  | Address | Description                        | Write   | Read            |
|-----------|---------|------------------------------------|---|-----------------|
| Baud Rate | 0x0303  | Configure gripper Modbus Baud rate | 0-5: 115200, 57600, 38400, 19200, 9600, 4800 (default: 0) | Current setting |

The value of this register is 0 by default, corresponding to a baud rate of 115200.

Example:

Set gripper baud rate to 115200 (write):

Send: 01 06 03 03 00 00 79 8E

Return: 01 06 03 03 00 00 79 8E

### 2.3.4.12 Stop Bits

This register is used to set Stop Bits of gripper.

The address is 0x0302. The description of this register is shown in Table 2.15.

Table 2.15 Stop bits settings

| Function  | Address | Description                        | Write   | Read            |
|-----------|---------|------------------------------------|---|-----------------|
| Stop Bits | 0x0304  | Configure gripper Modbus stop bits | 0: 1 stop bit<br>1: 2 stop bits<br>(default: 0) | Current setting |

The value of this register is 0 by default, corresponding to 1 stop bit.

Example:

Set the gripper stop bit to 1 stop bit (write):

Send: 01 06 03 04 00 00 C8 4F

Return: 01 06 03 04 00 00 C8 4F

### 2.3.4.13 Parity

This register is used to set Parity of gripper.

The address is 0x0305. The description of this register is shown in Table 2.16.

Table 2.16 Parity

| Function | Address | Description                     | Write  | Read            |
|----------|---------|---------------------------------|--|-----------------|
| Parity   | 0x0305  | Configure gripper Modbus Parity | 0: None Parity<br>1: Odd Parity<br>2: Even Parity<br>(default : 0) | Current setting |

The value of this register is 0 by default, corresponding to None Parity.

Example:

Set the gripper's Parity to None Parity (write):

Send: 01 06 03 05 00 00 99 8F

Return: 01 06 03 05 00 00 99 8F

### 2.3.4.14 Test I/O Parameters

This register is used to test the I/O Parameters.

The address is 0x0400. The description of this register is shown in Table 2.17.

Table 2.17 I/O Control

| Function            | Address | Description         | Write      | Read            |
|---------------------|---------|---------------------|------------|-----------------|
| Test I/O Parameters | 0x0400  | Test I/O Parameters | 1; 2; 3; 4 | Current setting |

This register can be used to directly test 4 groups of I/O parameters through Modbus-RTU to ensure that the I/O parameters are appropriate. For example, Write 1 to this register, the gripper will execute action with the first group of I/O parameter.

Example:

Control gripper by using first group of I/O parameter (write):

Send: 01 06 04 00 00 01 49 3A

Return: 01 06 04 00 00 01 49 3A

### 2.3.4.15 I/O Mode Switch

This register is used to turn I/O Control Mode ON or OFF.

The address is 0x0402. The description of this register is shown in Table 2.18.

Table 2.18 I/O Mode Switch

| Function        | Address | Description        | Write         | Read            |
|-----------------|---------|--------------------|---------------|-----------------|
| I/O Mode Switch | 0x0402  | I/O Control Switch | 0: OFF, 1: ON | Current setting |

If you have written 1 to this register and have saved all parameters, the gripper will be initialized automatically after power on.

When the I/O Control Mode is turned on, the gripper can respond to Modbus-RTU commands and I/O, but I/O has priority.

The control method in different mode is shown in Table 2.19.

Table 2.19 Control method

| Switch State | Description          | Modbus-RTU | I/O |
|--------------|----------------------|------------|-----|
| 0            | I/O control mode off | YES        | No  |
| 1            | I/O control mode on  | YES        | YES |

Example:

Set the I/O control mode switch off (write):

Send: 01 06 04 02 00 00 29 3A

Return: 01 06 04 02 00 00 29 3A

#### NOTE

- If you just need to control the gripper through Modbus RTU, you should write 0 to this register and save all parameters to turn off the I/O control mode.

### 2.3.4.16 I/O Parameter Configuration

Those registers are used to Set the I/O Parameters.

The address is 0x0405-0x0410. The description of this register is shown in Table 2.20.

Table 2.20 I/O Parameter Configuration

| Function    | High-byte | Low bytes | Description | Write    | Read            |
|-------------|-----------|-----------|-------------|----------|-----------------|
| I/O Group 1 | 0x04      | 0x05      | position 1  | 0-1000‰  | Current setting |
|             |           | 0x06      | force 1     | 20-100 % |                 |
|             |           | 0x07      | speed 1     | 1-100 %  |                 |
| I/O Group 2 |           | 0x08      | position 2  | 0-1000‰  |                 |
|             |           | 0x09      | force 2     | 20-100 % |                 |
|             |           | 0x0A      | speed 2     | 1-100 %  |                 |
| I/O Group 3 |           | 0x0B      | position 3  | 0-1000‰  |                 |
|             |           | 0x0C      | force 3     | 20-100 % |                 |
|             |           | 0x0D      | speed 3     | 1-100 %  |                 |
| I/O Group 4 |           | 0x0E      | position 4  | 0-1000‰  |                 |
|             |           | 0x0F      | force 4     | 20-100 % |                 |
|             |           | 0x10      | speed 4     | 1-100 %  |                 |

Example:

Set the first group of I/O parameter (write) :

Send: 01 06 04 05 01 2C 98 B6 (Reference position: 300‰)

Return: 01 06 04 05 01 2C 98 B6

Send: 01 06 04 06 00 1E E8 F3 (Force: 30‰)

Return: 01 06 04 06 00 1E E8 F3

Send: 01 06 04 07 00 1E B9 33 (Speed: 30‰)

Return: 01 06 04 07 00 1E B9 33

IO parameter address is continuous address, and four groups of IO parameters can be configured at one time by using the function code of 0x10, as follows:

Continuous multiple address write(write)[**Group 1**:1000‰position;20%force;10%speed **Group 2**:100‰position;20%force;2%speed **Group 3**:0‰position;100%force;5%speed **Group 4**:592‰position;100%force;10%speed]:

Send: 01 10 0405 000C 18 03e8 0014 000A 0100 0014 0002 0000 0064 0005 0250 0064 000a 9f 44

Return: 01 10 04 05 00 0C D1 3D

## 3 I/O Control

IO mode is a common control method in the industry, which controls the clamping jaws in the form of hardware wiring. When using IO control, you need to set the gripper jaws to IO mode in advance, and set the 4 groups of gripper IO states.

### 3.1 I/O Configuration

The I/O mode is a common control method in industry.

The grippers will monitor the pin states of Input 1 and Input 2 (0V and high resistance states). For these two pins, there will be four logic states:00,01,10,11. You can control this gripper through changing the states of Input 1 and Input 2. As shown in Table 3.1. The specific configuration is shown in the figure below:

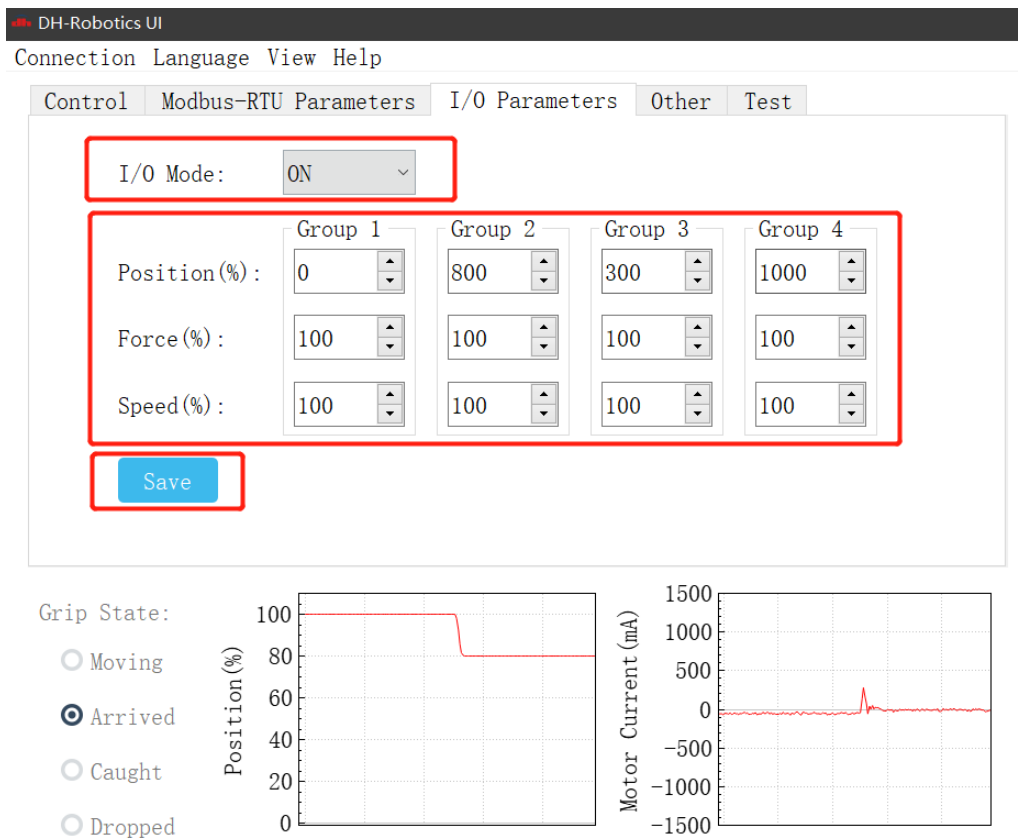

Figure 3.1 I/O mode

### Steps to switch IO mode

- ① **Open IO mode:** open IO mode first.
- ② **Configure four groups of IO parameters:** set the four groups of parameters of gripper, including position, force and speed.
- ③ **Save:** click the Save button to write the parameters to the internal register of flash, and restart to control.
- ④ **Restart:** after the restart, the switch to IO mode is successful. You can control the gripper according to the input signal, and the running status will be fed back through output.

Table 3.1 Input State

| INPUT 1   | INPUT 2   | Pin state | I/O state | Perform action                                  |
|-----------|-----------|-----------|-----------|---|
| No wiring | No wiring | 0 0       | Group 1   | Target position 1,target force 1,target speed 1 |
| 0V        | No wiring | 1 0       | Group 2   | Target position 2,Target Force 2,Target Speed 2 |
| No wiring | 0V        | 0 1       | Group 3   | Target position 3,Target Force 3,Target Speed 3 |
| 0V        | 0V        | 1 1       | Group 4   | Target position 4,Target force 4,target speed 4 |

You can also get the gripper state by detecting the states of Output1 and Output 2(0V and high resistance states). as shown in Table 3.2.

Table 3.2 Output1 Output2 State

| OUTPUT 1  | OUTPUT 2  | I/O State | State description  |
|-----------|-----------|-----------|--|
| No wiring | No wiring | 0 0       | Fingers are in motion  |
| 0V        | No wiring | 1 0       | Fingers are at reference position, No object detected or object has been dropped |
| No wiring | 0V        | 0 1       | Fingers have stopped due to an object detection                                  |
| 0V        | 0V        | 1 1       | The gripper detects an object falling  |

**NOTE**

- Digital IO default input and output are NPN type, input and output are 0V valid (low level valid).
- Input and output can be configured. If it needs to be changed to PNP type, the input and output of 24 V is effective (high level is effective), it is necessary to communicate with our company in advance.

### 3.2 IO use

After configuring the parameters, 24V, GND, INPUT 1, INPUT 2, OUTPUT 1, and OUTPUT 2 need to be connected to the hardware.

Connect INPUT and OUPUT to the corresponding equipment, confirm that the wiring is correct and restart, the gripper will automatically initialize. Then control the gripper according to the INPUT signal. The running status will be fed back through OUTPUT.